

別添①：配筋表【べた基礎】

モジュール	：	尺モジュール
積雪区分	：	多雪区域（1.5m以下）
屋根材	：	重い屋根
スラブ厚	：	150mm
基礎幅	：	150mm
コンクリートの 設計基準強度	：	18N/mm ²

- ・ 基礎梁配筋仕様 ……配筋表 P - 1
- ・ べた基礎底盤の配筋 ……配筋表 P - 7
- ・ 基礎梁の開口部（柱間隔）直下の主筋補強
 - 1) 《 標準基礎 》 ……配筋表 P - 8
 - 2) 《 地中梁 》 ……配筋表 P - 22
 - 3) 《 人通口 》 ……配筋表 P - 30
- ・ 基礎梁の隅角部の主筋補強 ……配筋表 P - 31

配筋表パターン一覧

（基礎幅：150mm、スラブ厚：150mm、コンクリート設計基準強度18N/m²は共通）

モジュール	屋根種類	積雪区分
尺	軽い屋根	一般地域
		多雪（1.0m以下）
		多雪（1.5m以下）
		多雪（2.0m以下）
	重い屋根	一般地域
		多雪（1.0m以下）
		多雪（1.5m以下）
		多雪（2.0m以下）
メーター	軽い屋根	一般地域
		多雪（1.0m以下）
		多雪（1.5m以下）
		多雪（2.0m以下）
	重い屋根	一般地域
		多雪（1.0m以下）
		多雪（1.5m以下）
		多雪（2.0m以下）

1. 基礎梁配筋仕様

各種配筋表の配筋仕様は下記の通りです。

基礎梁の開口部（柱間隔）直下の主筋補強《 標準基礎 》

基礎梁隅角部の主筋補強

主筋 ① : D13、② : D13+D10、③ : 2-D13、④ : D13+D16、⑤ : 2-D16

上下部主筋をそれぞれ上記主筋とします。

下記断面図は主筋部に鉄筋が2本配置されていますが① : D13 の場合は1本で問題ありません。

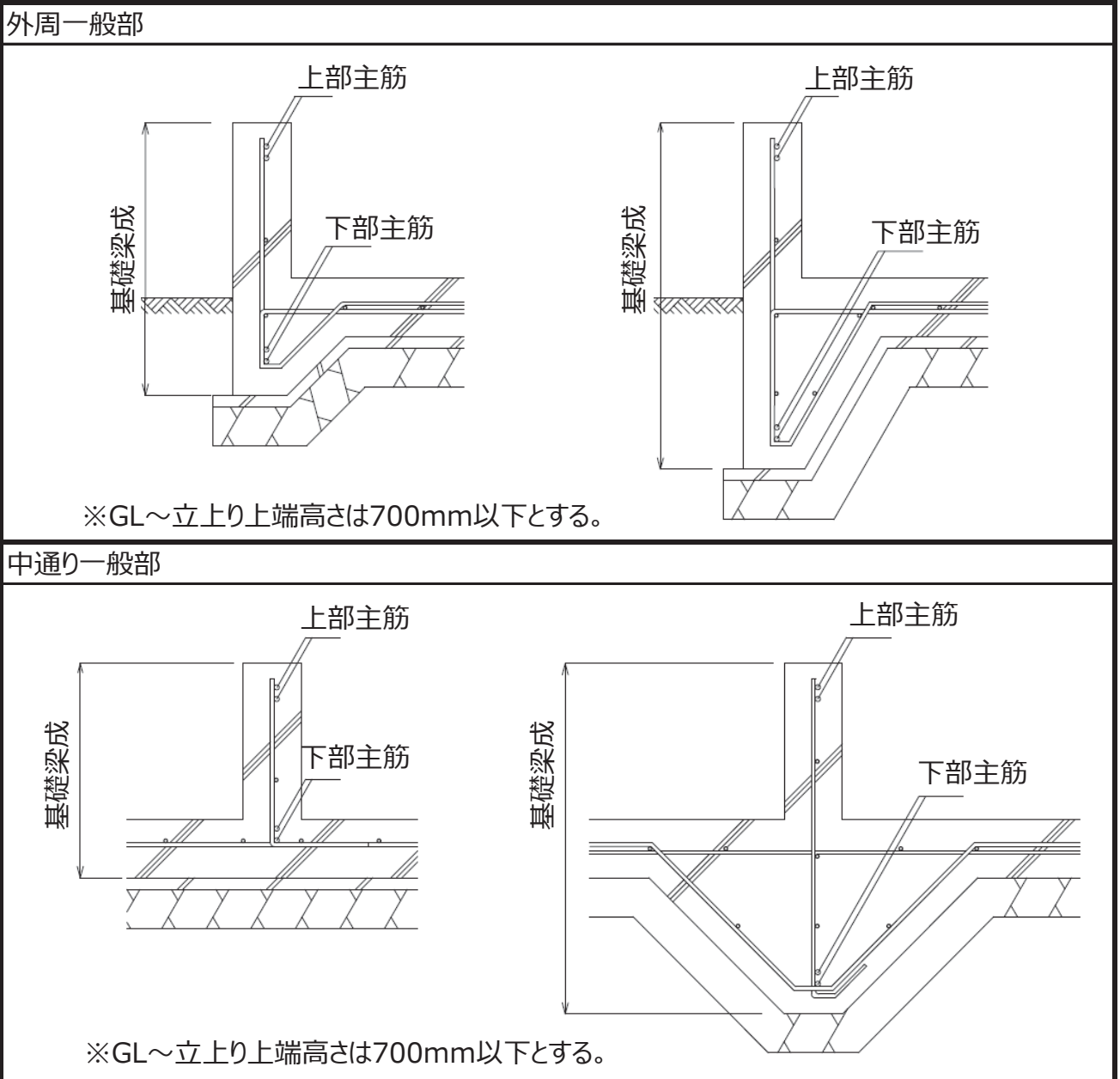

基礎梁の開口部（柱間隔）直下の主筋補強《 地中梁 》-1

① : 1-D13(15)

外周部

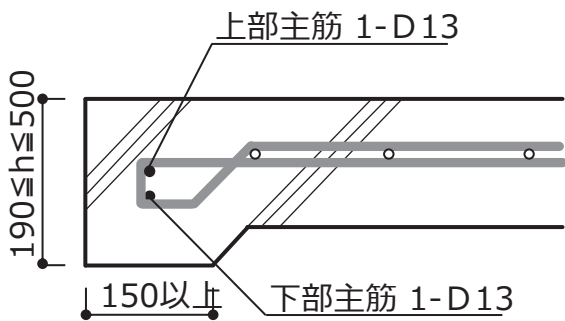

中通り

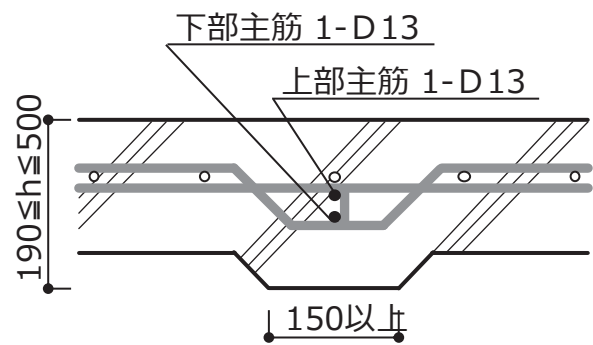

② : 2-D13(縦) (15)

外周部

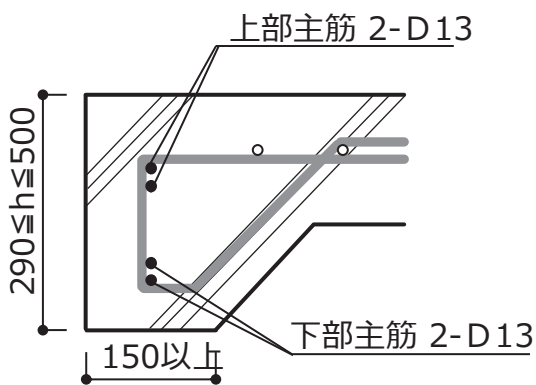

中通り

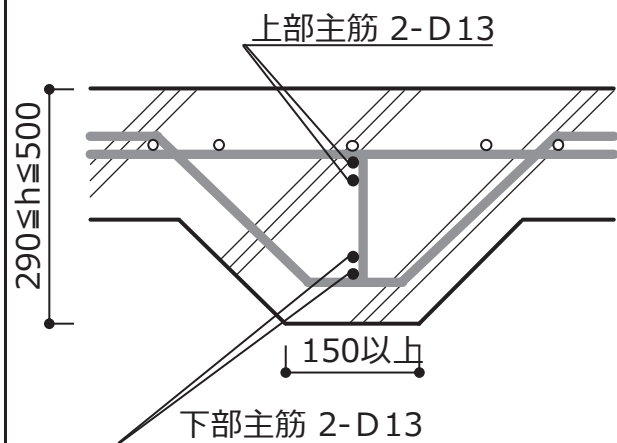

③ : 2-D13(横) (25)

外周部

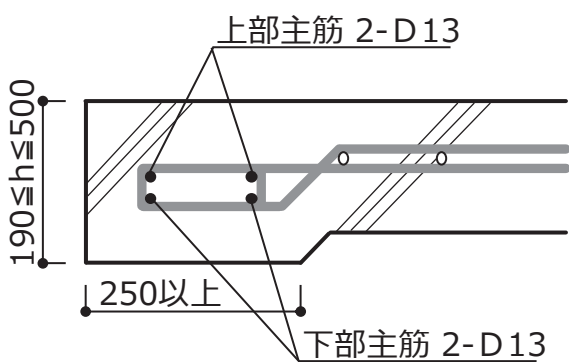

中通り

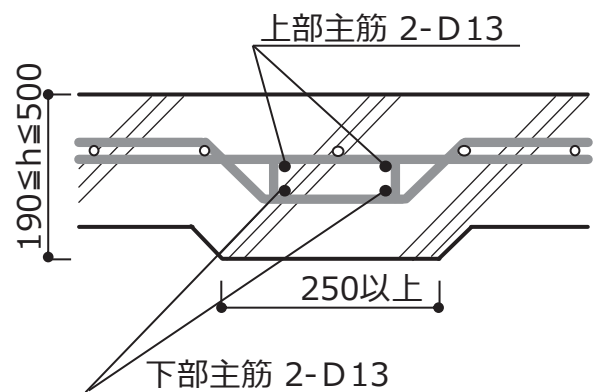

基礎梁の開口部（柱間隔）直下の主筋補強《 地中梁 》-2

④ : 3-D13(30)

外周部

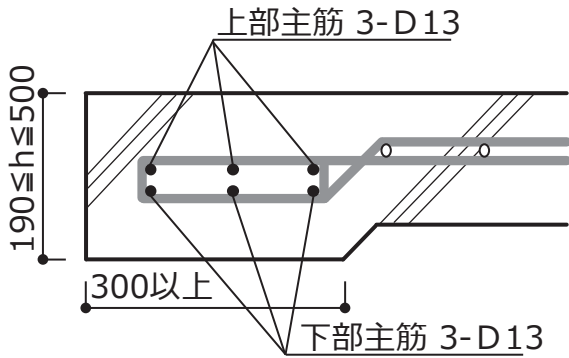

中通り

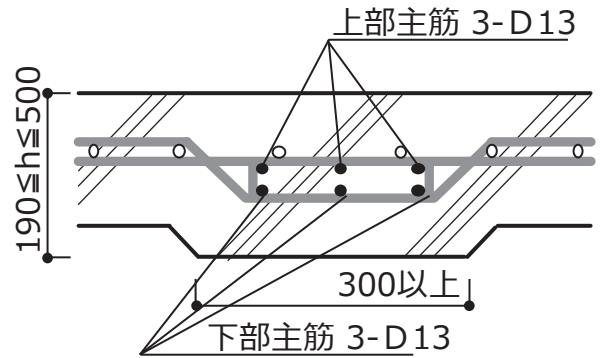

⑤ : 4-D13(35)

外周部

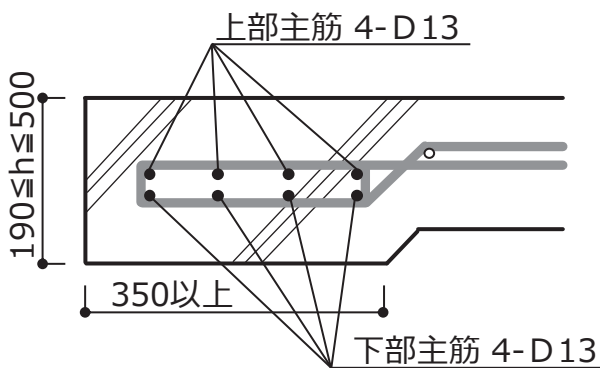

中通り

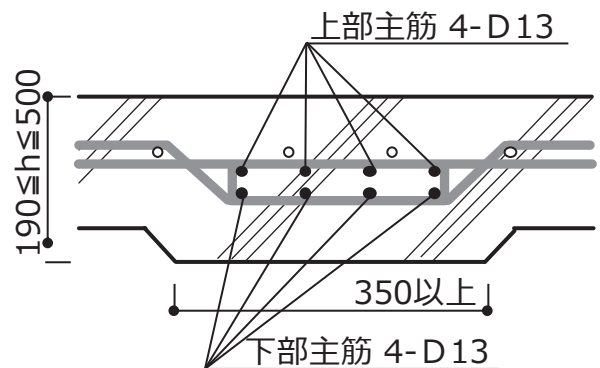

⑥ : 5-D13(40)

外周部

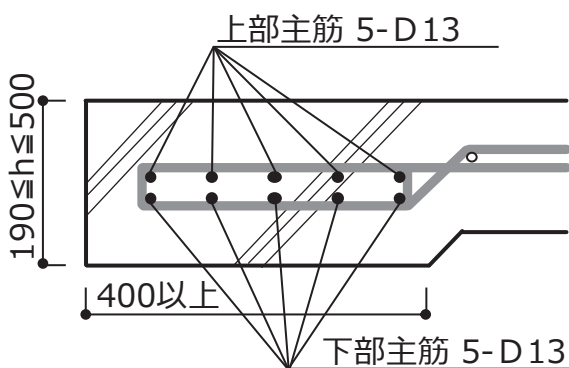

中通り

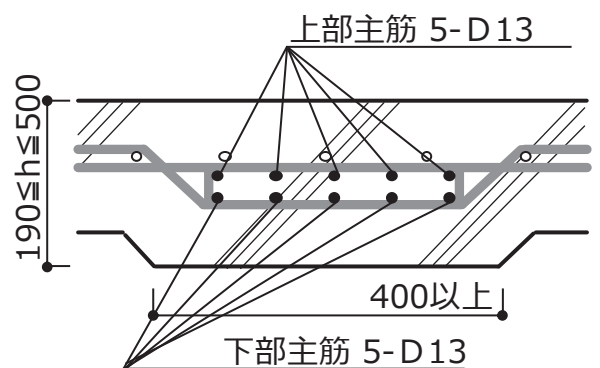

基礎梁の開口部（柱間隔）直下の主筋補強《 地中梁 》-3

⑦ : 6-D13(45)

外周部

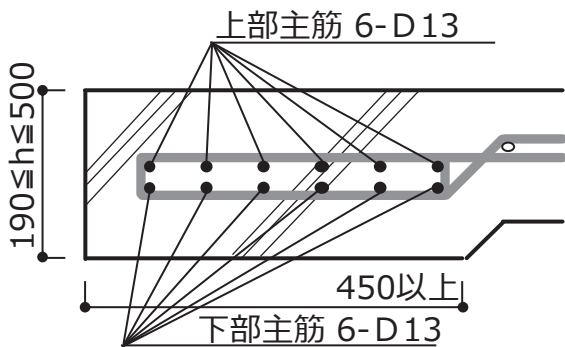

中通り

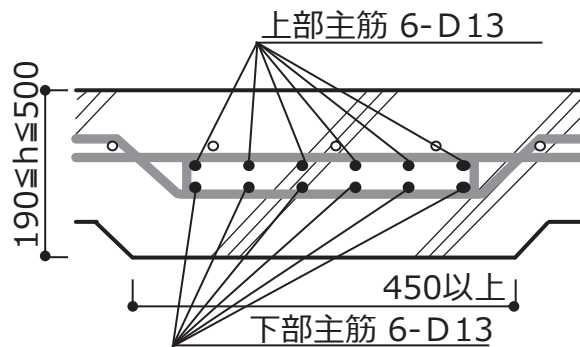

⑧ : 7-D13(50)

外周部

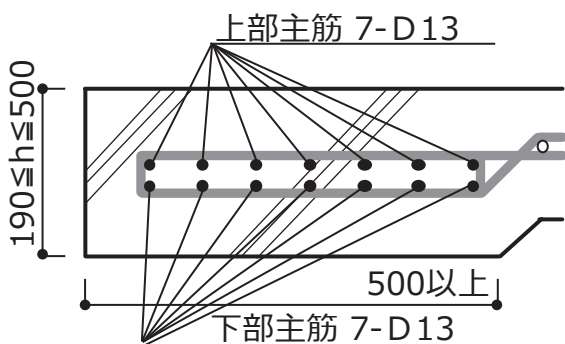

中通り

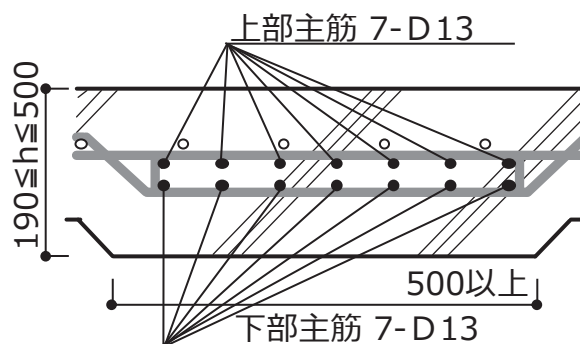

基礎梁の開口部（柱間隔）直下の主筋補強《 人通口 》-1

人通口の補強は下記範囲を補強します。

補強筋は人通口両端750mmの範囲内に指定種類・本数（主筋含む）の補強筋を配置します。

※下記は配筋表の判定が④：7-D13の場合の配筋方法となります。

※別途斜筋補強は必要です。（基礎仕様マニュアルP-6参照）

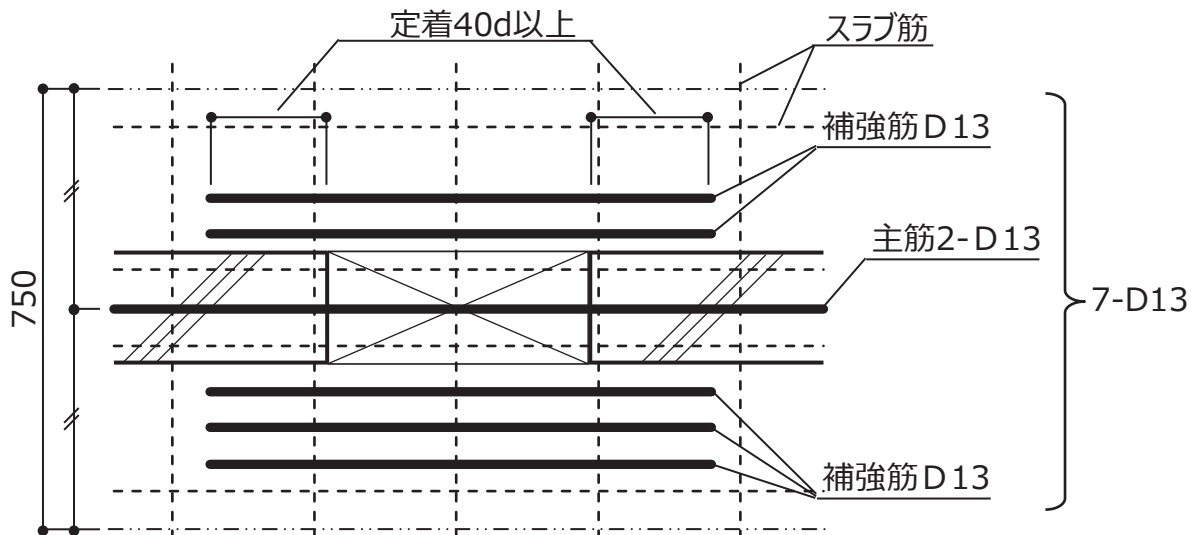

主筋をシングル配筋としている場合は上下で配置された主筋は横並びに置き換えて配置してください

※下記は配筋表の判定が②：2-D13の場合の配筋方法となります。

必要補強が②：2-D13の場合

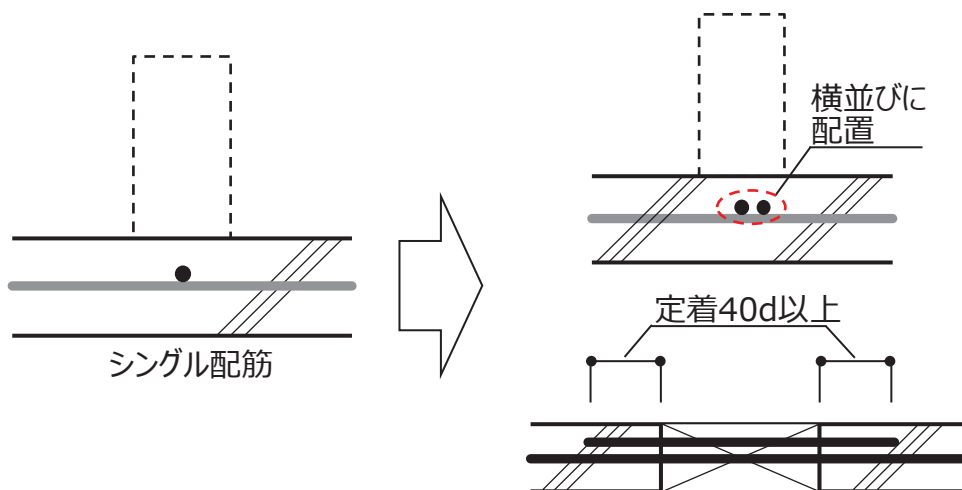

①：D13	②：2-D13

基礎梁の開口部（柱間隔）直下の主筋補強《 人通口 》-2

<p>③ : 5-D13</p> <p>● 主筋 ○ 補強筋</p> <p>主筋</p> <p>5-D13</p> <p>150以上</p> <p>750</p>	<p>④ : 7-D13</p> <p>主筋</p> <p>7-D13</p> <p>150以上</p> <p>750</p>
<p>⑤ : 9-D13</p> <p>主筋</p> <p>9-D13</p> <p>150以上</p> <p>750</p>	<p>⑥ : D13+7-D16</p> <p>主筋</p> <p>D13+7-D16</p> <p>150以上</p> <p>750</p>
<p>⑦ : 地3-D16</p> <p>あばら筋 : D13@200</p> <p>3-D16</p> <p>400以上</p> <p>400以上</p>	<p>⑧ : 地5-D16</p> <p>あばら筋 : D13@200</p> <p>5-D16</p> <p>400以上</p> <p>400以上</p>
<p>⑨ : 地5(50)5-D16</p> <p>あばら筋 : D13@200</p> <p>5-D16</p> <p>500以上</p> <p>400以上</p>	<p>※②～⑥の主筋は縦並びで配置していますが ダブル配筋時に上側のコンクリートのかぶり厚が 確保できない場合は横並びに配筋してください。 詳細は基礎仕様マニュアルP6を参照してください。</p>

配筋表：べた基礎底盤の配筋

【 多雪区域（1.5m以下） 重い屋根 スラブ厚150mm 】

《 配筋凡例 》 ①：D10@200 ②：D10@150 ③：D13@200 ④：D13@150 ⑤：D13@100

※黒塗りつぶし箇所は配筋の適用範囲外です。

積雪区分	階数	短辺長さ Lx (m)	短辺に対する長辺長さLy (m)			
			Ly ≤ Lx	Ly ≤ 1.5Lx	Ly ≤ 2Lx	Ly > 2Lx
多雪区域 (1.5m以下)	平屋建て	1.82 (m) 以下	①	①	①	①
		2.275 (m) 以下	①	①	①	①
		2.73 (m) 以下	①	①	②	②
		3.185 (m) 以下	①	②	③	③
		3.64 (m) 以下	①	③	④	④
		4.095 (m) 以下	②	④	④	⑤
		4.55 (m) 以下	③	⑤	⑤	⑤
	2階建て	1.82 (m) 以下	①	①	①	①
		2.275 (m) 以下	①	①	①	①
		2.73 (m) 以下	①	②	③	③
		3.185 (m) 以下	①	③	④	④
		3.64 (m) 以下	②	④	⑤	⑤
		4.095 (m) 以下	③	⑤	⑤	⑤
		4.55 (m) 以下	④	⑤		

配筋表：基礎梁の開口部（柱間隔）直下の補強筋《標準基礎》

【多雪区域（1.5m以下） 重い屋根 基礎幅150mm】 *印がついている場合：あばら筋を@200に変更が必要です。

《補強筋凡例》 ①：D13 ②：D13+D10 ③：2-D13 ④：D13+D16 ⑤：2-D16

*標準主筋が2-D13の場合、配筋表の①：D13、②：D13+D10は③：2-D13で置き換えてください。 ※黒塗りつぶし箇所は配筋の適用範囲外です。

基礎梁成 (mm)	階数	負担面積 (㎡)	柱間隔 (m) と開口部位置															
			0 < 柱間隔 ≤ 0.91		0.91 < 柱間隔 ≤ 1.82		1.82 < 柱間隔 ≤ 2.73		2.73 < 柱間隔 ≤ 3.64		3.64 < 柱間隔 ≤ 4.55		4.55 < 柱間隔 ≤ 5.46		5.46 < 柱間隔 ≤ 6.37			
			中央寄り	片側寄り	中央寄り	片側寄り	中央寄り	片側寄り	中央寄り	片側寄り	中央寄り	片側寄り	中央寄り	片側寄り	中央寄り	片側寄り		
400以上	平屋建て	1	①	①	①	①	①	①	①	①	①	①	①	①	②	①	②	
		1.5	①	①	①	①	①	①	①	①	①	②	②	①	②	③	②	④
		2	①	①	①	①	①	①	①	②	②	③	②	④	③		③	
		2.5	①	①	①	①	①	①	②	②	④	③		④				
		3	①	①	①	②	②	③	③		④							
		3.5	①	①	①	②	②	④	③									
		4	①	①	①	②	②	③	③		⑤							
		4.5	①	①	①	②	②	④	③		⑤							
		5	①	①	①	②	②	⑤	④									
		5.5	①	①	②	③	③		⑤									
		6	①*	①*	②*	③*	③*											
		6.5	①*	①*	②*	④*	④*											
	7	①*	②*	②*	④*	④*												
	7.5	①*	②*	②*	⑤*	⑤*												
	8	①*	②*	③*														
	8.5	①*	②*	③*														
	9	①*	②*	③*														
	9.5	①*	②*	③*														
	10	①*	②*	④*														
	11	②*	③*	⑤*														
	12	②*	③*															
	13																	
	14																	
	15																	
	16																	
	17																	
	18																	
	19																	
	20																	
	22																	
	24																	
	26																	
	28																	
	30																	
	35																	
400以上	2階建て	1	①	①	①	①	①	①	①	①	①	①	①	②	①	②		
		1.5	①	①	①	①	①	①	①	②	②	①	②	③	②	④		
		2	①	①	①	①	①	②	②	③	②	④	③		③			
		2.5	①	①	①	①	①	②	②	④	③		④					
		3	①	①	①	②	②	③	③		④							
		3.5	①	①	①	②	②	④	③									
		4	①	①	②	③	③		⑤									
		4.5	①*	①*	②*	③*	③*											
		5	①*	①*	②*	④*	④*											
		5.5	①*	②*	②*	⑤*	⑤*											
		6	①*	②*	③*													
	6.5	①*	②*	③*														
	7	①*	②*	③*														
	7.5	①*	②*	④*														
	8	②*	③*	⑤*														
	8.5	②*	③*	⑤*														
	9	②*	③*															
	9.5																	
	10																	
	11																	
	12																	
	13																	
	14																	
15																		
16																		
17																		
18																		
19																		
20																		
22																		
24																		
26																		
28																		
30																		
35																		

配筋表：基礎梁の開口部（柱間隔）直下の補強筋《標準基礎》

【多雪区域（1.5m以下） 重い屋根 基礎幅150mm】 *印がついている場合：あばら筋を@200に変更が必要です。

《補強筋凡例》 ①：D13 ②：D13+D10 ③：2-D13 ④：D13+D16 ⑤：2-D16

*標準主筋が2-D13の場合、配筋表の①：D13、②：D13+D10は③：2-D13で置き換えてください。 ※黒塗りつぶし箇所は配筋の適用範囲外です。

基礎梁成 (mm)	階数	負担面積 (㎡)	柱間隔 (m) と開口部位置														
			0 < 柱間隔 ≤ 0.91		0.91 < 柱間隔 ≤ 1.82		1.82 < 柱間隔 ≤ 2.73		2.73 < 柱間隔 ≤ 3.64		3.64 < 柱間隔 ≤ 4.55		4.55 < 柱間隔 ≤ 5.46		5.46 < 柱間隔 ≤ 6.37		
			中央寄り	片側寄り	中央寄り	片側寄り	中央寄り	片側寄り	中央寄り	片側寄り	中央寄り	片側寄り	中央寄り	片側寄り	中央寄り	片側寄り	
450以上	平屋建て	1	①	①	①	①	①	①	①	①	①	①	①	①	①	①	
		1.5	①	①	①	①	①	①	①	①	①	①	①	①	②	①	②
		2	①	①	①	①	①	①	①	②	①	②	②	②	②	③	③
		2.5	①	①	①	①	①	①	①	②	②	③	②	③	③	③	④
		3	①	①	①	①	①	②	②	②	②	③	②	④	③		
		3.5	①	①	①	①	①	②	②	③	②	④	③			④	
		4	①	①	①	②	②	②	②	④	③	⑤	④			⑤	
		4.5	①	①	①	②	②	③	②	④	③			④			
		5	①	①	①	②	②	③	③	⑤	④			⑤			
		5.5	①	①	①	②	②	④	③		④						
		6	①	①	②	②	②	④	④		⑤						
		6.5	①*	①*	②*	③*	③*	⑤*	④*								
		7	①*	①*	②*	③*	③*		⑤*								
		7.5	①*	①*	②*	③*	③*		⑤*								
		8	①*	②*	②*	④*	④*										
		8.5	①*	②*	②*	④*	④*										
		9	①*	②*	②*	④*	④*										
	9.5	①*	②*	③*	⑤*	⑤*											
	10	①*	②*	③*	⑤*	⑤*											
	11	①*	②*	③*													
	12	②*	②*	④*													
	13	②*	③*	④*													
	14	②*	③*	⑤*													
	15																
	16																
	17																
	18																
	19																
	20																
	22																
	24																
	26																
	28																
	30																
	35																
2階建て	1	①	①	①	①	①	①	①	①	①	①	①	②	①	②		
	1.5	①	①	①	①	①	①	①	②	①	②	②	②	②	③		
	2	①	①	①	①	①	②	①	②	②	③	②	④	③	⑤		
	2.5	①	①	①	①	①	②	②	③	②	④	③	⑤	③			
	3	①	①	①	②	②	②	②	④	③	⑤	④		⑤			
	3.5	①	①	①	②	②	③	③	⑤	③		⑤					
	4	①	①	①	②	②	④	③		④							
	4.5	①	①	②	②	②	④	④		⑤							
	5	①*	①*	②*	③*	③*	⑤*	④*									
	5.5	①*	①*	②*	③*	③*		⑤*									
	6	①*	②*	②*	④*	④*											
	6.5	①*	②*	②*	④*	④*											
	7	①*	②*	③*	⑤*	⑤*											
	7.5	①*	②*	③*	⑤*	⑤*											
	8	①*	②*	③*													
	8.5	①*	②*	③*													
	9	②*	②*	④*													
	9.5	②*	③*	④*													
10	②*	③*	④*														
11																	
12																	
13																	
14																	
15																	
16																	
17																	
18																	
19																	
20																	
22																	
24																	
26																	
28																	
30																	
35																	

配筋表：基礎梁の開口部（柱間隔）直下の補強筋《標準基礎》

【多雪区域（1.5m以下） 重い屋根 基礎幅150mm】 *印がついている場合：あばら筋を@200に変更が必要です。

《補強筋凡例》 ①：D13 ②：D13+D10 ③：2-D13 ④：D13+D16 ⑤：2-D16

※標準主筋が2-D13の場合、配筋表の①：D13、②：D13+D10は③：2-D13で置き換えてください。 ※黒塗りつぶし箇所は配筋の適用範囲外です。

基礎梁成 (mm)	階数	負担面積 (㎡)	柱間隔 (m) と開口部位置													
			0 < 柱間隔 ≤ 0.91		0.91 < 柱間隔 ≤ 1.82		1.82 < 柱間隔 ≤ 2.73		2.73 < 柱間隔 ≤ 3.64		3.64 < 柱間隔 ≤ 4.55		4.55 < 柱間隔 ≤ 5.46		5.46 < 柱間隔 ≤ 6.37	
			中央寄り	片側寄り	中央寄り	片側寄り	中央寄り	片側寄り	中央寄り	片側寄り	中央寄り	片側寄り	中央寄り	片側寄り	中央寄り	片側寄り
500 以上	平屋建て	1	①	①	①	①	①	①	①	①	①	①	①	①	①	①
		1.5	①	①	①	①	①	①	①	①	①	①	①	①	①	①
		2	①	①	①	①	①	①	①	①	①	①	②	①	②	②
		2.5	①	①	①	①	①	①	①	②	①	②	②	③	②	③
		3	①	①	①	①	①	①	①	②	②	③	②	③	②	④
		3.5	①	①	①	①	①	②	②	②	②	③	②	④	③	⑤
		4	①	①	①	①	①	②	②	③	②	④	③	⑤	④	
		4.5	①	①	①	①	①	②	②	③	③	④	③		④	
		5	①	①	①	②	②	③	②	④	③	⑤	④		④	
		5.5	①	①	①	②	②	③	③	④	④		④		⑤	
		6	①	①	①	②	②	③	③	⑤	④		⑤			
		6.5	①	①	①	②	②	④	③		④					
		7	①	①	②	②	②	④	④		④					
		7.5	①*	①*	②*	③*	③*	④*	④*		⑤*					
		8	①*	①*	②*	③*	③*	⑤*	④*							
		8.5	①*	①*	②*	③*	③*	⑤*	④*							
		9	①*	①*	②*	③*	③*		⑤*							
	9.5	①*	②*	②*	④*	④*		⑤*								
	10	①*	②*	②*	④*	④*										
	11	①*	②*	③*	④*	④*										
	12	①*	②*	③*	⑤*	⑤*										
	13	①*	②*	③*												
	14	②*	②*	④*												
	15	②*	③*	④*												
	16	②*	③*	④*												
	17															
	18															
	19															
	20															
	22															
	24															
	26															
	28															
	30															
	35															
2階建て	1	①	①	①	①	①	①	①	①	①	①	①	①	①	②	
	1.5	①	①	①	①	①	①	①	①	①	②	①	②	②	②	
	2	①	①	①	①	①	①	①	②	①	②	②	③	②	④	
	2.5	①	①	①	①	①	①	②	①	②	②	③	②	④	⑤	
	3	①	①	①	①	①	①	②	②	③	②	④	③	⑤	④	
	3.5	①	①	①	②	②	②	②	④	③	⑤	④		④		
	4	①	①	①	②	②	③	③	④	③		④		⑤		
	4.5	①	①	①	②	②	③	③	⑤	④		⑤				
	5	①	①	①	②	②	④	③		④						
	5.5	①	①	②	③	③	④	④		⑤						
	6	①*	①*	②*	③*	③*	⑤*	④*								
	6.5	①*	①*	②*	③*	③*		④*								
	7	①*	②*	②*	④*	④*		⑤*								
	7.5	①*	②*	②*	④*	④*										
	8	①*	②*	③*	④*	④*										
	8.5	①*	②*	③*	④*	④*										
	9	①*	②*	③*	⑤*	⑤*										
	9.5	①*	②*	③*	⑤*	⑤*										
10	①*	②*	③*													
11	②*	③*	④*													
12	②*	③*	④*													
13																
14																
15																
16																
17																
18																
19																
20																
22																
24																
26																
28																
30																
35																

配筋表：基礎梁の開口部（柱間隔）直下の補強筋《標準基礎》

【多雪区域（1.5m以下） 重い屋根 基礎幅150mm】 *印がついている場合：あばら筋を@200に変更が必要です。

《補強筋凡例》 ①：D13 ②：D13+D10 ③：2-D13 ④：D13+D16 ⑤：2-D16

※標準主筋が2-D13の場合、配筋表の①：D13、②：D13+D10は③：2-D13で置き換えてください。 ※黒塗りつぶし箇所は配筋の適用範囲外です。

基礎梁成 (mm)	階数	負担面積 (㎡)	柱間隔 (m) と開口部位置													
			0 < 柱間隔 ≤ 0.91		0.91 < 柱間隔 ≤ 1.82		1.82 < 柱間隔 ≤ 2.73		2.73 < 柱間隔 ≤ 3.64		3.64 < 柱間隔 ≤ 4.55		4.55 < 柱間隔 ≤ 5.46		5.46 < 柱間隔 ≤ 6.37	
			中央寄り	片側寄り	中央寄り	片側寄り	中央寄り	片側寄り	中央寄り	片側寄り	中央寄り	片側寄り	中央寄り	片側寄り	中央寄り	片側寄り
520 以上	平屋建て	1	①	①	①	①	①	①	①	①	①	①	①	①	①	①
		1.5	①	①	①	①	①	①	①	①	①	①	①	①	①	②
		2	①	①	①	①	①	①	①	①	①	②	①	②	①	②
		2.5	①	①	①	①	①	①	①	②	①	②	②	③	②	③
		3	①	①	①	①	①	①	①	②	②	③	②	③	②	④
		3.5	①	①	①	①	①	②	①	②	②	③	②	④	③	④
		4	①	①	①	①	①	②	②	③	②	④	③	④	③	
		4.5	①	①	①	①	①	②	②	③	③	④	③	⑤	④	
		5	①	①	①	②	②	③	②	④	③	⑤	④		④	
		5.5	①	①	①	②	②	③	②	④	③	⑤	④		⑤	
		6	①	①	①	②	②	③	③	④	④		④			
		6.5	①	①	①	②	②	④	③	⑤	④		⑤			
		7	①	①	①	②	②	④	③		④					
		7.5	①	①	②	③	③	④	④		⑤					
		8	①*	①*	②*	③*	③*	④*	④*		⑤*					
		8.5	①*	①*	②*	③*	③*	⑤*	④*							
		9	①*	①*	②*	③*	③*	⑤*	④*							
	9.5	①*	①*	②*	③*	③*		⑤*								
	10	①*	②*	②*	④*	④*		⑤*								
	11	①*	②*	②*	④*	④*										
	12	①*	②*	③*	④*	④*										
	13	①*	②*	③*	⑤*	⑤*										
	14	①*	②*	③*												
	15	②*	③*	④*												
	16	②*	③*	④*												
	17	②*	③*	④*												
	18															
	19															
	20															
	22															
	24															
	26															
	28															
	30															
	35															
2階建て	1	①	①	①	①	①	①	①	①	①	①	①	①	①	①	
	1.5	①	①	①	①	①	①	①	①	①	②	①	②	①	②	
	2	①	①	①	①	①	①	①	②	①	②	②	③	②	③	
	2.5	①	①	①	①	①	①	②	①	②	②	③	②	④	③	
	3	①	①	①	①	①	①	②	②	③	②	④	③	④	③	
	3.5	①	①	①	①	①	②	②	③	③	④	③		④		
	4	①	①	①	②	②	③	②	④	③	⑤	④		⑤		
	4.5	①	①	①	②	②	③	③	④	④		④				
	5	①	①	①	②	②	④	③	⑤	④		⑤				
	5.5	①	①	②	②	②	④	④		④						
	6	①*	①*	②*	③*	③*	④*	④*		⑤*						
	6.5	①*	①*	②*	③*	③*	⑤*	④*								
	7	①*	①*	②*	③*	③*		⑤*								
	7.5	①*	②*	②*	④*	④*		⑤*								
	8	①*	②*	②*	④*	④*										
	8.5	①*	②*	③*	④*	④*										
	9	①*	②*	③*	④*	④*										
	9.5	①*	②*	③*	⑤*	⑤*										
10	①*	②*	③*	⑤*	⑤*											
11	②*	②*	④*													
12	②*	③*	④*													
13																
14																
15																
16																
17																
18																
19																
20																
22																
24																
26																
28																
30																
35																

配筋表：基礎梁の開口部（柱間隔）直下の補強筋《標準基礎》

【多雪区域（1.5m以下） 重い屋根 基礎幅150mm】 *印がついている場合：あばら筋を@200に変更が必要です。

《補強筋凡例》 ①：D13 ②：D13+D10 ③：2-D13 ④：D13+D16 ⑤：2-D16

※標準主筋が2-D13の場合、配筋表の①：D13、②：D13+D10は③：2-D13で置き換えてください。 ※黒塗りつぶし箇所は配筋の適用範囲外です。

基礎梁成 (mm)	階数	負担面積 (㎡)	柱間隔 (m) と開口部位置													
			0 < 柱間隔 ≤ 0.91		0.91 < 柱間隔 ≤ 1.82		1.82 < 柱間隔 ≤ 2.73		2.73 < 柱間隔 ≤ 3.64		3.64 < 柱間隔 ≤ 4.55		4.55 < 柱間隔 ≤ 5.46		5.46 < 柱間隔 ≤ 6.37	
			中央寄り	片側寄り	中央寄り	片側寄り	中央寄り	片側寄り	中央寄り	片側寄り	中央寄り	片側寄り	中央寄り	片側寄り	中央寄り	片側寄り
550以上	平屋建て	1	①	①	①	①	①	①	①	①	①	①	①	①	①	①
		1.5	①	①	①	①	①	①	①	①	①	①	①	①	①	②
		2	①	①	①	①	①	①	①	①	①	①	①	②	③	④
		2.5	①	①	①	①	①	①	①	①	②	③	②	③	④	⑤
		3	①	①	①	①	①	②	②	③	②	③	③	④	⑤	⑥
		3.5	①	①	①	①	①	②	②	③	②	④	③	⑤	⑥	⑦
		4	①	①	①	①	①	②	②	③	②	④	③	⑤	⑥	⑦
		4.5	①	①	①	①	①	②	②	③	②	④	③	⑤	⑥	⑦
		5	①	①	①	①	①	②	②	③	③	④	④	⑤	⑥	⑦
		5.5	①	①	①	②	②	③	②	④	③	⑤	④	⑥	⑦	⑧
		6	①	①	①	②	②	③	③	④	③	⑤	④	⑥	⑦	⑧
		6.5	①	①	①	②	②	③	③	④	④	⑥	⑤	⑦	⑧	⑨
		7	①	①	①	②	②	④	③	⑤	④	⑥	⑤	⑦	⑧	⑨
		7.5	①	①	①	②	②	④	③	⑤	④	⑥	⑤	⑦	⑧	⑨
		8	①	①	②	③	③	④	④	⑥	⑤	⑦	⑥	⑧	⑨	⑩
		8.5	①*	①*	②*	③*	③*	④*	④*	⑥*	⑤*	⑦*	⑥*	⑧*	⑨*	⑩*
		9	①*	①*	②*	③*	③*	④*	④*	⑥*	⑤*	⑦*	⑥*	⑧*	⑨*	⑩*
		9.5	①*	①*	②*	③*	③*	④*	④*	⑥*	⑤*	⑦*	⑥*	⑧*	⑨*	⑩*
	10	①*	①*	②*	③*	③*	④*	④*	⑥*	⑤*	⑦*	⑥*	⑧*	⑨*	⑩*	
	11	①*	②*	③*	④*	④*	⑥*	⑤*	⑦*	⑥*	⑧*	⑦*	⑨*	⑩*	⑪*	
	12	①*	②*	③*	④*	④*	⑥*	⑤*	⑦*	⑥*	⑧*	⑦*	⑨*	⑩*	⑪*	
	13	①*	②*	③*	④*	④*	⑥*	⑤*	⑦*	⑥*	⑧*	⑦*	⑨*	⑩*	⑪*	
	14	①*	②*	③*	④*	④*	⑥*	⑤*	⑦*	⑥*	⑧*	⑦*	⑨*	⑩*	⑪*	
	15	①*	②*	③*	④*	④*	⑥*	⑤*	⑦*	⑥*	⑧*	⑦*	⑨*	⑩*	⑪*	
	16	②*	③*	④*	⑥*	⑤*	⑦*	⑥*	⑧*	⑦*	⑨*	⑧*	⑩*	⑪*	⑫*	
	17	②*	③*	④*	⑥*	⑤*	⑦*	⑥*	⑧*	⑦*	⑨*	⑧*	⑩*	⑪*	⑫*	
	18	②*	③*	④*	⑥*	⑤*	⑦*	⑥*	⑧*	⑦*	⑨*	⑧*	⑩*	⑪*	⑫*	
	19															
	20															
	22															
	24															
	26															
	28															
	30															
	35															
2階建て	1	①	①	①	①	①	①	①	①	①	①	①	①	①	①	
	1.5	①	①	①	①	①	①	①	①	①	①	①	②	③	④	
	2	①	①	①	①	①	①	①	②	③	②	③	④	⑤	⑥	
	2.5	①	①	①	①	①	①	①	②	③	②	③	④	⑤	⑥	
	3	①	①	①	①	①	②	②	③	②	③	③	④	⑤	⑥	
	3.5	①	①	①	①	①	②	②	③	②	④	③	⑤	⑥	⑦	
	4	①	①	①	②	②	③	②	④	③	⑤	④	⑥	⑦	⑧	
	4.5	①	①	①	②	②	③	③	④	③	⑤	④	⑥	⑦	⑧	
	5	①	①	①	②	②	③	③	④	④	⑥	⑤	⑦	⑧	⑨	
	5.5	①	①	①	②	②	④	③	⑤	④	⑥	⑤	⑦	⑧	⑨	
	6	①	①	②	③	③	④	④	⑥	⑤	⑦	⑥	⑧	⑨	⑩	
	6.5	①*	①*	②*	③*	③*	④*	④*	⑥*	⑤*	⑦*	⑥*	⑧*	⑨*	⑩*	
	7	①*	①*	②*	③*	③*	④*	④*	⑥*	⑤*	⑦*	⑥*	⑧*	⑨*	⑩*	
	7.5	①*	①*	②*	③*	③*	④*	④*	⑥*	⑤*	⑦*	⑥*	⑧*	⑨*	⑩*	
	8	①*	②*	③*	④*	④*	⑥*	⑤*	⑦*	⑥*	⑧*	⑦*	⑨*	⑩*	⑪*	
	8.5	①*	②*	③*	④*	④*	⑥*	⑤*	⑦*	⑥*	⑧*	⑦*	⑨*	⑩*	⑪*	
	9	①*	②*	③*	④*	④*	⑥*	⑤*	⑦*	⑥*	⑧*	⑦*	⑨*	⑩*	⑪*	
9.5	①*	②*	③*	④*	④*	⑥*	⑤*	⑦*	⑥*	⑧*	⑦*	⑨*	⑩*	⑪*		
10	①*	②*	③*	④*	④*	⑥*	⑤*	⑦*	⑥*	⑧*	⑦*	⑨*	⑩*	⑪*		
11	①*	②*	③*	④*	④*	⑥*	⑤*	⑦*	⑥*	⑧*	⑦*	⑨*	⑩*	⑪*		
12	②*	③*	④*	⑥*	⑤*	⑦*	⑥*	⑧*	⑦*	⑨*	⑧*	⑩*	⑪*	⑫*		
13	②*	③*	④*	⑥*	⑤*	⑦*	⑥*	⑧*	⑦*	⑨*	⑧*	⑩*	⑪*	⑫*		
14																
15																
16																
17																
18																
19																
20																
22																
24																
26																
28																
30																
35																

配筋表：基礎梁の開口部（柱間隔）直下の補強筋《標準基礎》

【多雪区域（1.5m以下） 重い屋根 基礎幅150mm】 *印がついている場合：あばら筋を@200に変更が必要です。

《補強筋凡例》 ①：D13 ②：D13+D10 ③：2-D13 ④：D13+D16 ⑤：2-D16

※標準主筋が2-D13の場合、配筋表の①：D13、②：D13+D10は③：2-D13で置き換えてください。 ※黒塗りつぶし箇所は配筋の適用範囲外です。

基礎梁成 (mm)	階数	負担面積 (㎡)	柱間隔 (m) と開口部位置													
			0 < 柱間隔 ≤ 0.91		0.91 < 柱間隔 ≤ 1.82		1.82 < 柱間隔 ≤ 2.73		2.73 < 柱間隔 ≤ 3.64		3.64 < 柱間隔 ≤ 4.55		4.55 < 柱間隔 ≤ 5.46		5.46 < 柱間隔 ≤ 6.37	
			中央寄り	片側寄り	中央寄り	片側寄り	中央寄り	片側寄り	中央寄り	片側寄り	中央寄り	片側寄り	中央寄り	片側寄り	中央寄り	片側寄り
600以上	平屋建て	1	①	①	①	①	①	①	①	①	①	①	①	①	①	①
		1.5	①	①	①	①	①	①	①	①	①	①	①	①	①	①
		2	①	①	①	①	①	①	①	①	①	①	①	①	①	①
		2.5	①	①	①	①	①	①	①	①	①	②	①	②	②	②
		3	①	①	①	①	①	①	①	②	①	②	②	③	②	③
		3.5	①	①	①	①	①	①	①	②	②	③	②	③	③	④
		4	①	①	①	①	①	②	①	②	②	③	②	④	③	④
		4.5	①	①	①	①	①	②	②	③	②	③	③	④	③	⑤
		5	①	①	①	①	①	②	②	③	②	④	③	⑤	④	⑤
		5.5	①	①	①	①	①	②	②	③	③	④	③	⑤	④	
		6	①	①	①	②	②	③	②	④	③	⑤	④		④	
		6.5	①	①	①	②	②	③	②	④	③	⑤	④		⑤	
		7	①	①	①	②	②	③	③	④	④	⑤	④		⑤	
		7.5	①	①	①	②	②	③	③	⑤	④		⑤		⑤	
		8	①	①	①	②	②	④	③	⑤	④		⑤			
		8.5	①	①	①	②	②	④	③	⑤	④		⑤			
		9	①	①	②	③	③	④	④		⑤					
		9.5	①	* ①	* ②	* ③	* ③	* ④	* ④		⑤	*				
		10	①	* ①	* ②	* ③	* ③	* ⑤	* ④		⑤	*				
		11	①	* ①	* ②	* ③	* ③	* ⑤	* ⑤							
	12	①	* ②	* ②	* ④	* ④		⑤	*							
	13	①	* ②	* ②	* ④	* ④		⑤	*							
	14	①	* ②	* ③	* ④	* ④										
	15	①	* ②	* ③	* ⑤	* ⑤										
	16	①	* ②	* ③	* ⑤	* ⑤										
	17	①	* ②	* ③	* ⑤	* ⑤										
	18	②	* ③	* ④												
	19	②	* ③	* ④												
	20	②	* ③	* ④												
	22															
	24															
	26															
	28															
	30															
	35															
2階建て	1	①	①	①	①	①	①	①	①	①	①	①	①	①	①	
	1.5	①	①	①	①	①	①	①	①	①	①	②	①	②	②	
	2	①	①	①	①	①	①	①	①	①	②	①	②	②	③	
	2.5	①	①	①	①	①	①	①	②	①	②	②	③	②	④	
	3	①	①	①	①	①	②	①	②	②	③	②	④	③	④	
	3.5	①	①	①	①	①	②	②	③	②	④	③	④	③	⑤	
	4	①	①	①	①	①	②	②	③	③	④	③	⑤	④		
	4.5	①	①	①	②	②	③	②	④	③	⑤	④		④		
	5	①	①	①	②	②	③	③	④	③	⑤	④		⑤		
	5.5	①	①	①	②	②	③	③	⑤	④		⑤		⑤		
	6	①	①	①	②	②	④	③	⑤	④		⑤				
	6.5	①	①	②	②	②	④	④	⑤	④		⑤				
	7	①	* ①	* ②	* ③	* ③	* ④	* ④		⑤	*					
	7.5	①	* ①	* ②	* ③	* ③	* ⑤	* ④		⑤	*					
	8	①	* ①	* ②	* ③	* ③	* ⑤	* ④								
8.5	①	* ①	* ②	* ③	* ④	* ⑤	* ⑤									
9	①	* ②	* ②	* ④	* ④		⑤	*								
9.5	①	* ②	* ②	* ④	* ④		⑤	*								
10	①	* ②	* ③	* ④	* ④											
11	①	* ②	* ③	* ⑤	* ⑤											
12	①	* ②	* ③	* ⑤	* ⑤											
13	②	* ②	* ④	* ⑤	* ⑤											
14	②	* ③	* ④													
15	②	* ③	* ④													
16																
17																
18																
19																
20																
22																
24																
26																
28																
30																
35																

配筋表：基礎梁の開口部（柱間隔）直下の補強筋《標準基礎》

【多雪区域（1.5m以下） 重い屋根 基礎幅150mm】 *印がついている場合：あばら筋を@200に変更が必要です。

《補強筋凡例》 ①：D13 ②：D13+D10 ③：2-D13 ④：D13+D16 ⑤：2-D16

※標準主筋が2-D13の場合、配筋表の①：D13、②：D13+D10は③：2-D13で置き換えてください。 ※黒塗りつぶし箇所は配筋の適用範囲外です。

基礎梁成 (mm)	階数	負担面積 (㎡)	柱間隔 (m) と開口部位置														
			0 < 柱間隔 ≤ 0.91		0.91 < 柱間隔 ≤ 1.82		1.82 < 柱間隔 ≤ 2.73		2.73 < 柱間隔 ≤ 3.64		3.64 < 柱間隔 ≤ 4.55		4.55 < 柱間隔 ≤ 5.46		5.46 < 柱間隔 ≤ 6.37		
			中央寄り	片側寄り	中央寄り	片側寄り	中央寄り	片側寄り	中央寄り	片側寄り	中央寄り	片側寄り	中央寄り	片側寄り	中央寄り	片側寄り	
650以上	平屋建て	1	①	①	①	①	①	①	①	①	①	①	①	①	①	①	
		1.5	①	①	①	①	①	①	①	①	①	①	①	①	①	①	
		2	①	①	①	①	①	①	①	①	①	①	①	①	①	①	
		2.5	①	①	①	①	①	①	①	①	①	①	①	②	①	②	
		3	①	①	①	①	①	①	①	①	①	①	②	①	②	②	③
		3.5	①	①	①	①	①	①	①	①	②	①	②	②	③	②	③
		4	①	①	①	①	①	①	①	②	②	③	②	③	②	③	④
		4.5	①	①	①	①	①	②	①	②	②	③	②	④	③	④	④
		5	①	①	①	①	①	②	②	③	②	③	③	④	④	③	⑤
		5.5	①	①	①	①	①	②	②	③	②	④	③	⑤	④	⑤	⑤
		6	①	①	①	①	①	②	②	③	③	④	③	⑤	④	⑤	
		6.5	①	①	①	②	②	②	②	④	③	⑤	④	⑤	④	⑤	
		7	①	①	①	②	②	③	②	④	③	⑤	④		⑤		
		7.5	①	①	①	②	②	③	③	④	③	⑤	④		⑤		
		8	①	①	①	②	②	③	③	④	④		④		⑤		
		8.5	①	①	①	②	②	④	③	⑤	④		⑤				
		9	①	①	①	②	②	④	③	⑤	④		⑤				
		9.5	①	①	②	②	②	④	④	⑤	④		⑤				
		10	①	①	②	③	③	④	④		⑤						
		11	①*	①*	②*	③*	③*	⑤*	④*		⑤*						
	12	①*	①*	②*	③*	③*	⑤*	④*									
	13	①*	②*	②*	④*	④*	⑤*	⑤*									
	14	①*	②*	②*	④*	④*		⑤*									
	15	①*	②*	③*	④*	④*											
	16	①*	②*	③*	④*	④*											
	17	①*	②*	③*	⑤*	⑤*											
	18	①*	②*	③*	⑤*	⑤*											
	19	②*	②*	④*	⑤*	⑤*											
	20	②*	③*	④*													
	22	②*	③*	④*													
	24																
	26																
	28																
	30																
	35																
2階建て	1	①	①	①	①	①	①	①	①	①	①	①	①	①	①		
	1.5	①	①	①	①	①	①	①	①	①	①	①	①	①	②		
	2	①	①	①	①	①	①	①	①	①	②	①	②	①	②		
	2.5	①	①	①	①	①	①	①	②	①	②	②	③	②	③		
	3	①	①	①	①	①	①	①	②	②	③	②	③	②	④		
	3.5	①	①	①	①	①	②	①	②	②	③	②	④	③	⑤		
	4	①	①	①	①	①	②	②	③	②	④	③	⑤	③	⑤		
	4.5	①	①	①	①	①	②	②	③	③	④	③	⑤	④			
	5	①	①	①	②	②	③	②	④	③	⑤	④		④			
	5.5	①	①	①	②	②	③	③	④	③	⑤	④		⑤			
	6	①	①	①	②	②	③	③	⑤	④		⑤		⑤			
	6.5	①	①	①	②	②	④	③	⑤	④		⑤					
	7	①	①	①	②	②	④	③	⑤	④		⑤					
	7.5	①	①	②	③	③	④	④		⑤							
	8	①*	①*	②*	③*	③*	⑤*	④*		⑤*							
8.5	①*	①*	②*	③*	③*	⑤*	④*		⑤*								
9	①*	①*	②*	③*	③*	⑤*	⑤*										
9.5	①*	②*	②*	④*	④*	⑤*	⑤*										
10	①*	②*	②*	④*	④*		⑤*										
11	①*	②*	③*	④*	④*												
12	①*	②*	③*	④*	⑤*												
13	①*	②*	③*	⑤*	⑤*												
14	①*	②*	③*	⑤*	⑤*												
15	②*	③*	④*														
16	②*	③*	④*														
17																	
18																	
19																	
20																	
22																	
24																	
26																	
28																	
30																	
35																	

配筋表：基礎梁の開口部（柱間隔）直下の補強筋《標準基礎》

【多雪区域（1.5m以下） 重い屋根 基礎幅150mm】 *印がついている場合：あばら筋を@200に変更が必要です。

《補強筋凡例》 ①：D13 ②：D13+D10 ③：2-D13 ④：D13+D16 ⑤：2-D16

※標準主筋が2-D13の場合、配筋表の①：D13、②：D13+D10は③：2-D13で置き換えてください。 ※黒塗りつぶし箇所は配筋の適用範囲外です。

基礎梁成 (mm)	階数	負担面積 (㎡)	柱間隔 (m) と開口部位置													
			0 < 柱間隔 ≤ 0.91		0.91 < 柱間隔 ≤ 1.82		1.82 < 柱間隔 ≤ 2.73		2.73 < 柱間隔 ≤ 3.64		3.64 < 柱間隔 ≤ 4.55		4.55 < 柱間隔 ≤ 5.46		5.46 < 柱間隔 ≤ 6.37	
			中央寄り	片側寄り	中央寄り	片側寄り	中央寄り	片側寄り	中央寄り	片側寄り	中央寄り	片側寄り	中央寄り	片側寄り	中央寄り	片側寄り
700以上	平屋建て	1	①	①	①	①	①	①	①	①	①	①	①	①	①	①
		1.5	①	①	①	①	①	①	①	①	①	①	①	①	①	①
		2	①	①	①	①	①	①	①	①	①	①	①	①	①	①
		2.5	①	①	①	①	①	①	①	①	①	①	①	②	①	②
		3	①	①	①	①	①	①	①	①	①	①	②	①	②	②
		3.5	①	①	①	①	①	①	①	①	②	①	②	②	②	③
		4	①	①	①	①	①	①	①	②	②	①	②	②	③	②
		4.5	①	①	①	①	①	①	①	②	②	②	③	②	③	②
		5	①	①	①	①	①	②	①	②	②	②	③	②	④	③
		5.5	①	①	①	①	①	②	②	③	②	④	③	④	③	⑤
		6	①	①	①	①	①	②	②	③	②	④	③	⑤	④	⑤
		6.5	①	①	①	①	①	②	②	③	③	④	③	⑤	④	
		7	①	①	①	②	②	②	②	④	③	④	④	⑤	④	
		7.5	①	①	①	②	②	③	②	④	③	⑤	④		④	
		8	①	①	①	②	②	③	③	④	③	⑤	④		⑤	
		8.5	①	①	①	②	②	③	③	④	④	⑤	④		⑤	
		9	①	①	①	②	②	③	③	⑤	④		⑤		⑤	
		9.5	①	①	①	②	②	④	③	⑤	④		⑤			
		10	①	①	①	②	②	④	③	⑤	④		⑤			
		11	①	①	②	③	③	④	④		⑤					
	12	①*	①*	②*	③*	③*	⑤*	④*		⑤*						
	13	①*	①*	②*	③*	③*	⑤*	④*								
	14	①*	②*	②*	④*	④*	⑤*	⑤*								
	15	①*	②*	②*	④*	④*		⑤*								
	16	①*	②*	③*	④*	④*		⑤*								
	17	①*	②*	③*	④*	④*										
	18	①*	②*	③*	⑤*	⑤*										
	19	①*	②*	③*	⑤*	⑤*										
	20	①*	②*	③*	⑤*	⑤*										
	22	②*	③*	④*												
	24	②*	③*	④*												
	26															
	28															
	30															
	35															
2階建て	1	①	①	①	①	①	①	①	①	①	①	①	①	①	①	
	1.5	①	①	①	①	①	①	①	①	①	①	①	①	①	②	
	2	①	①	①	①	①	①	①	①	①	①	①	②	①	②	
	2.5	①	①	①	①	①	①	①	①	①	②	①	②	②	③	
	3	①	①	①	①	①	①	①	②	①	②	②	③	②	④	
	3.5	①	①	①	①	①	②	①	②	②	③	②	④	③	④	
	4	①	①	①	①	①	②	②	③	②	③	③	④	③	⑤	
	4.5	①	①	①	①	①	②	②	③	②	④	③	⑤	④	⑤	
	5	①	①	①	①	①	②	②	③	③	④	③	⑤	④		
	5.5	①	①	①	②	②	③	②	④	③	⑤	④		④		
	6	①	①	①	②	②	③	③	④	③	⑤	④		⑤		
	6.5	①	①	①	②	②	③	③	④	④		④		⑤		
	7	①	①	①	②	②	④	③	⑤	④		⑤				
	7.5	①	①	①	②	②	④	③	⑤	④		⑤				
	8	①	①	②	③	③	④	④		⑤						
8.5	①*	①*	②*	③*	③*	④*	④*		⑤*							
9	①*	①*	②*	③*	③*	⑤*	④*		⑤*							
9.5	①*	①*	②*	③*	③*	⑤*	④*		⑤*							
10	①*	①*	②*	③*	③*	⑤*	⑤*									
11	①*	②*	②*	④*	④*		⑤*									
12	①*	②*	③*	④*	④*											
13	①*	②*	③*	④*	④*											
14	①*	②*	③*	⑤*	⑤*											
15	①*	②*	③*	⑤*	⑤*											
16	②*	③*	④*													
17	②*	③*	④*													
18	②*	③*	④*													
19																
20																
22																
24																
26																
28																
30																
35																

配筋表：基礎梁の開口部（柱間隔）直下の補強筋《標準基礎》

【多雪区域（1.5m以下） 重い屋根 基礎幅150mm】 *印がついている場合：あばら筋を@200に変更が必要です。

《補強筋凡例》 ①：D13 ②：D13+D10 ③：2-D13 ④：D13+D16 ⑤：2-D16

※標準主筋が2-D13の場合、配筋表の①：D13、②：D13+D10は③：2-D13で置き換えてください。 ※黒塗りつぶし箇所は配筋の適用範囲外です。

基礎梁成 (mm)	階数	負担面積 (㎡)	柱間隔 (m) と開口部位置														
			0 < 柱間隔 ≤ 0.91		0.91 < 柱間隔 ≤ 1.82		1.82 < 柱間隔 ≤ 2.73		2.73 < 柱間隔 ≤ 3.64		3.64 < 柱間隔 ≤ 4.55		4.55 < 柱間隔 ≤ 5.46		5.46 < 柱間隔 ≤ 6.37		
			中央寄り	片側寄り	中央寄り	片側寄り	中央寄り	片側寄り	中央寄り	片側寄り	中央寄り	片側寄り	中央寄り	片側寄り	中央寄り	片側寄り	
750以上	平屋建て	1	①	①	①	①	①	①	①	①	①	①	①	①	①	①	
		1.5	①	①	①	①	①	①	①	①	①	①	①	①	①	①	
		2	①	①	①	①	①	①	①	①	①	①	①	①	①	①	
		2.5	①	①	①	①	①	①	①	①	①	①	①	②	①	②	
		3	①	①	①	①	①	①	①	①	①	①	②	①	②	①	②
		3.5	①	①	①	①	①	①	①	①	①	①	②	①	②	②	③
		4	①	①	①	①	①	①	①	②	①	②	②	③	②	③	④
		4.5	①	①	①	①	①	①	①	②	②	②	③	③	④	③	④
		5	①	①	①	①	①	②	①	②	②	③	③	④	④	⑤	④
		5.5	①	①	①	①	①	②	②	②	②	③	③	④	④	⑤	⑤
		6	①	①	①	①	①	②	②	③	②	④	③	④	④	⑤	⑤
		6.5	①	①	①	①	①	②	②	③	③	④	④	⑤	④	⑤	⑤
		7	①	①	①	①	①	②	②	③	③	④	④	⑤	④	⑤	
		7.5	①	①	①	②	②	②	②	④	③	④	④	⑤	④	⑤	
		8	①	①	①	②	②	③	②	④	③	⑤	④	⑤	④	⑤	
		8.5	①	①	①	②	②	③	②	④	③	⑤	④	⑤	④	⑤	
		9	①	①	①	②	②	③	③	④	④	⑤	④	⑤	④	⑤	
		9.5	①	①	①	②	②	③	③	④	④	⑤	④	⑤	④	⑤	
	10	①	①	①	②	②	④	③	⑤	④	⑤	④	⑤	④	⑤		
	11	①	①	①	②	②	④	③	⑤	④	⑤	④	⑤	④	⑤		
	12	①	①	②	③	③	④	④	⑤	④	⑤	④	⑤	④	⑤		
	13	①*	①*	②*	③*	③*	⑤*	④*	⑤*	④*	⑤*	④*	⑤*	④*	⑤*		
	14	①*	①*	②*	③*	③*	⑤*	④*	⑤*	④*	⑤*	④*	⑤*	④*	⑤*		
	15	①*	②*	②*	④*	④*	⑤*	⑤*	④*	⑤*	④*	⑤*	④*	⑤*	④*		
	16	①*	②*	②*	④*	④*	⑤*	⑤*	④*	⑤*	④*	⑤*	④*	⑤*	④*		
	17	①*	②*	②*	④*	④*	⑤*	⑤*	④*	⑤*	④*	⑤*	④*	⑤*	④*		
	18	①*	②*	③*	④*	④*	⑤*	⑤*	④*	⑤*	④*	⑤*	④*	⑤*	④*		
	19	①*	②*	③*	④*	④*	⑤*	⑤*	④*	⑤*	④*	⑤*	④*	⑤*	④*		
	20	①*	②*	③*	⑤*	⑤*	④*	⑤*	④*	⑤*	④*	⑤*	④*	⑤*	④*		
	22	①*	②*	③*	⑤*	⑤*	④*	⑤*	④*	⑤*	④*	⑤*	④*	⑤*	④*		
	24	②*	③*	④*													
	26	②*	③*	④*													
	28																
	30																
	35																
2階建て	1	①	①	①	①	①	①	①	①	①	①	①	①	①	①		
	1.5	①	①	①	①	①	①	①	①	①	①	①	①	①	①		
	2	①	①	①	①	①	①	①	①	①	①	①	①	①	①		
	2.5	①	①	①	①	①	①	①	①	①	①	②	①	②	③		
	3	①	①	①	①	①	①	①	②	①	②	②	③	②	③		
	3.5	①	①	①	①	①	①	①	②	②	③	②	③	②	④		
	4	①	①	①	①	①	②	①	②	②	③	②	④	③	④		
	4.5	①	①	①	①	①	②	②	③	②	④	③	④	③	⑤		
	5	①	①	①	①	①	②	②	③	②	④	③	⑤	④	⑤		
	5.5	①	①	①	①	①	②	②	③	③	④	③	⑤	④	⑤		
	6	①	①	①	②	②	③	②	④	③	⑤	④	⑤	④	⑤		
	6.5	①	①	①	②	②	③	③	④	③	⑤	④	⑤	④	⑤		
	7	①	①	①	②	②	③	③	④	④	⑤	④	⑤	④	⑤		
	7.5	①	①	①	②	②	④	③	⑤	④	⑤	④	⑤	④	⑤		
	8	①	①	①	②	②	④	③	⑤	④	⑤	④	⑤	④	⑤		
	8.5	①	①	②	②	②	④	④	⑤	④	⑤	④	⑤	④	⑤		
	9	①*	①*	②*	③*	③*	④*	④*	⑤*	④*	⑤*	④*	⑤*	④*	⑤*		
9.5	①*	①*	②*	③*	③*	⑤*	④*	⑤*	④*	⑤*	④*	⑤*	④*	⑤*			
10	①*	①*	②*	③*	③*	⑤*	④*	⑤*	④*	⑤*	④*	⑤*	④*	⑤*			
11	①*	①*	②*	③*	③*	⑤*	④*	⑤*	④*	⑤*	④*	⑤*	④*	⑤*			
12	①*	②*	②*	④*	④*	⑤*	⑤*	④*	⑤*	④*	⑤*	④*	⑤*	④*			
13	①*	②*	③*	④*	④*	⑤*	⑤*	④*	⑤*	④*	⑤*	④*	⑤*	④*			
14	①*	②*	③*	④*	④*	⑤*	⑤*	④*	⑤*	④*	⑤*	④*	⑤*	④*			
15	①*	②*	③*	⑤*	⑤*	④*	⑤*	④*	⑤*	④*	⑤*	④*	⑤*	④*			
16	①*	②*	③*	⑤*	⑤*	④*	⑤*	④*	⑤*	④*	⑤*	④*	⑤*	④*			
17	②*	②*	④*	⑤*	⑤*	④*	⑤*	④*	⑤*	④*	⑤*	④*	⑤*	④*			
18	②*	③*	④*														
19	②*	③*	④*														
20																	
22																	
24																	
26																	
28																	
30																	
35																	

配筋表：基礎梁の開口部（柱間隔）直下の補強筋《標準基礎》

【多雪区域（1.5m以下） 重い屋根 基礎幅150mm】 *印がついている場合：あばら筋を@200に変更が必要です。

《補強筋凡例》 ①：D13 ②：D13+D10 ③：2-D13 ④：D13+D16 ⑤：2-D16

※標準主筋が2-D13の場合、配筋表の①：D13、②：D13+D10は③：2-D13で置き換えてください。※黒塗りつぶし箇所は配筋の適用範囲外です。

基礎梁成 (mm)	階数	負担面積 (㎡)	柱間隔 (m) と開口部位置													
			0 < 柱間隔 ≤ 0.91		0.91 < 柱間隔 ≤ 1.82		1.82 < 柱間隔 ≤ 2.73		2.73 < 柱間隔 ≤ 3.64		3.64 < 柱間隔 ≤ 4.55		4.55 < 柱間隔 ≤ 5.46		5.46 < 柱間隔 ≤ 6.37	
			中央寄り	片側寄り	中央寄り	片側寄り	中央寄り	片側寄り	中央寄り	片側寄り	中央寄り	片側寄り	中央寄り	片側寄り	中央寄り	片側寄り
800以上	平屋建て	1	①	①	①	①	①	①	①	①	①	①	①	①	①	①
		1.5	①	①	①	①	①	①	①	①	①	①	①	①	①	①
		2	①	①	①	①	①	①	①	①	①	①	①	①	①	①
		2.5	①	①	①	①	①	①	①	①	①	①	①	①	①	②
		3	①	①	①	①	①	①	①	①	①	①	①	②	①	②
		3.5	①	①	①	①	①	①	①	①	①	②	①	②	②	②
		4	①	①	①	①	①	①	①	②	①	②	②	②	②	③
		4.5	①	①	①	①	①	①	①	②	②	③	②	③	②	③
		5	①	①	①	①	①	①	①	②	②	③	②	③	②	④
		5.5	①	①	①	①	①	②	①	②	②	③	②	④	③	④
		6	①	①	①	①	①	②	②	②	②	③	②	④	③	⑤
		6.5	①	①	①	①	①	②	②	③	②	④	③	④	③	⑤
		7	①	①	①	①	①	②	②	③	②	④	③	⑤	④	⑤
		7.5	①	①	①	①	①	②	②	③	③	④	③	⑤	④	
		8	①	①	①	②	②	②	②	④	③	④	④	⑤	④	
		8.5	①	①	①	②	②	③	②	④	③	⑤	④		④	
		9	①	①	①	②	②	③	②	④	③	⑤	④		⑤	
		9.5	①	①	①	②	②	③	③	④	③	⑤	④		⑤	
		10	①	①	①	②	②	③	③	④	④		④		⑤	
		11	①	①	①	②	②	④	③	⑤	④		⑤			
	12	①	①	②	②	②	④	④	⑤	④		⑤				
	13	①*	①*	②*	③*	③*	④*	④*		⑤*						
	14	①*	①*	②*	③*	③*	⑤*	④*		⑤*						
	15	①*	①*	②*	③*	③*	⑤*	④*								
	16	①*	②*	②*	④*	④*	⑤*	⑤*								
	17	①*	②*	②*	④*	④*		⑤*								
	18	①*	②*	②*	④*	④*		⑤*								
	19	①*	②*	③*	④*	④*										
	20	①*	②*	③*	④*	④*										
	22	①*	②*	③*	⑤*	⑤*										
	24	②*	②*	④*	⑤*	⑤*										
	26	②*	③*	④*												
	28	②*	③*	④*												
	30															
	35															
800以上	2階建て	1	①	①	①	①	①	①	①	①	①	①	①	①	①	
		1.5	①	①	①	①	①	①	①	①	①	①	①	①	①	
		2	①	①	①	①	①	①	①	①	①	①	②	①	②	
		2.5	①	①	①	①	①	①	①	①	①	②	①	②	②	
		3	①	①	①	①	①	①	①	②	①	②	②	②	③	
		3.5	①	①	①	①	①	①	①	②	①	②	②	③	②	④
		4	①	①	①	①	①	②	①	②	②	③	②	④	③	④
		4.5	①	①	①	①	①	②	②	②	②	③	②	④	③	⑤
		5	①	①	①	①	①	②	②	③	②	④	③	④	③	⑤
		5.5	①	①	①	①	①	②	②	③	②	④	③	⑤	④	
		6	①	①	①	②	②	②	②	④	③	④	④	⑤	④	
		6.5	①	①	①	②	②	③	②	④	③	⑤	④		④	
		7	①	①	①	②	②	③	③	④	③	⑤	④		⑤	
		7.5	①	①	①	②	②	③	③	④	④		④		⑤	
		8	①	①	①	②	②	④	③	⑤	④		⑤			
8.5	①	①	①	②	②	④	③	⑤	④		⑤					
9	①	①	②	③	③	④	④	⑤	④		⑤					
9.5	①	①	②	③	③	④	④		⑤							
10	①*	①*	②*	③*	③*	④*	④*		⑤*							
11	①*	①*	②*	③*	③*	⑤*	④*		⑤*							
12	①*	②*	②*	④*	④*	⑤*	⑤*									
13	①*	②*	②*	④*	④*		⑤*									
14	①*	②*	③*	④*	④*											
15	①*	②*	③*	④*	④*											
16	①*	②*	③*	⑤*	⑤*											
17	①*	②*	③*	⑤*	⑤*											
18	②*	②*	④*	⑤*	⑤*											
19	②*	③*	④*													
20	②*	③*	④*													
22																
24																
26																
28																
30																
35																

配筋表：基礎梁の開口部（柱間隔）直下の補強筋《標準基礎》

【多雪区域（1.5m以下） 重い屋根 基礎幅150mm】 *印がついている場合：あばら筋を@200に変更が必要です。

《補強筋凡例》 ①：D13 ②：D13+D10 ③：2-D13 ④：D13+D16 ⑤：2-D16

※標準主筋が2-D13の場合、配筋表の①：D13、②：D13+D10は③：2-D13で置き換えてください。 ※黒塗りつぶし箇所は配筋の適用範囲外です。

基礎梁成 (mm)	階数	負担面積 (㎡)	柱間隔 (m) と開口部位置													
			0 < 柱間隔 ≤ 0.91		0.91 < 柱間隔 ≤ 1.82		1.82 < 柱間隔 ≤ 2.73		2.73 < 柱間隔 ≤ 3.64		3.64 < 柱間隔 ≤ 4.55		4.55 < 柱間隔 ≤ 5.46		5.46 < 柱間隔 ≤ 6.37	
			中央寄り	片側寄り	中央寄り	片側寄り	中央寄り	片側寄り	中央寄り	片側寄り	中央寄り	片側寄り	中央寄り	片側寄り	中央寄り	片側寄り
850 以上	平屋建て	1	①	①	①	①	①	①	①	①	①	①	①	①	①	①
		1.5	①	①	①	①	①	①	①	①	①	①	①	①	①	①
		2	①	①	①	①	①	①	①	①	①	①	①	①	①	①
		2.5	①	①	①	①	①	①	①	①	①	①	①	①	①	②
		3	①	①	①	①	①	①	①	①	①	①	①	②	①	②
		3.5	①	①	①	①	①	①	①	①	①	②	①	②	①	②
		4	①	①	①	①	①	①	①	①	①	②	①	②	②	③
		4.5	①	①	①	①	①	①	①	②	①	②	②	③	②	③
		5	①	①	①	①	①	①	①	②	①	②	②	③	②	④
		5.5	①	①	①	①	①	①	①	②	②	③	②	③	②	④
		6	①	①	①	①	①	②	①	②	②	③	②	④	③	④
		6.5	①	①	①	①	①	②	②	②	②	③	②	④	③	⑤
		7	①	①	①	①	①	②	②	③	②	④	③	④	③	⑤
		7.5	①	①	①	①	①	②	②	③	②	④	③	⑤	④	⑤
		8	①	①	①	①	①	②	②	③	③	④	③	⑤	④	⑤
		8.5	①	①	①	①	①	②	②	③	③	④	③	⑤	④	
		9	①	①	①	②	②	③	②	④	③	⑤	④		④	
		9.5	①	①	①	②	②	③	②	④	③	⑤	④		⑤	
		10	①	①	①	②	②	③	③	④	③	⑤	④		⑤	
		11	①	①	①	②	②	③	③	⑤	④		⑤		⑤	
		12	①	①	①	②	②	④	③	⑤	④		⑤			
		13	①	①	②	②	②	④	④	⑤	④		⑤			
		14	①*	①*	②*	③*	③*	④*	④*		⑤*					
		15	①*	①*	②*	③*	③*	⑤*	④*		⑤*					
		16	①*	①*	②*	③*	③*	⑤*	④*		⑤*					
		17	①*	①*	②*	③*	③*	⑤*	⑤*							
		18	①*	②*	②*	④*	④*		⑤*							
		19	①*	②*	②*	④*	④*		⑤*							
		20	①*	②*	③*	④*	④*		⑤*							
		22	①*	②*	③*	⑤*	⑤*									
	24	①*	②*	③*	⑤*	⑤*										
	26	②*	②*	④*	⑤*	⑤*										
	28	②*	③*	④*												
	30	②*	③*	④*												
	35															
850 以下	2階建て	1	①	①	①	①	①	①	①	①	①	①	①	①	①	
		1.5	①	①	①	①	①	①	①	①	①	①	①	①	①	
		2	①	①	①	①	①	①	①	①	①	①	①	①	①	
		2.5	①	①	①	①	①	①	①	①	①	①	①	②	①	②
		3	①	①	①	①	①	①	①	①	①	②	①	②	②	③
		3.5	①	①	①	①	①	①	①	②	①	②	②	③	②	③
		4	①	①	①	①	①	①	①	②	②	③	②	③	②	④
		4.5	①	①	①	①	①	②	①	②	②	③	②	④	③	④
		5	①	①	①	①	①	②	②	③	②	③	③	④	③	⑤
		5.5	①	①	①	①	①	②	②	③	②	④	③	⑤	④	⑤
		6	①	①	①	①	①	②	②	③	③	④	③	⑤	④	
		6.5	①	①	①	②	②	②	②	④	③	④	④	⑤	④	
		7	①	①	①	②	②	③	②	④	③	⑤	④		④	
		7.5	①	①	①	②	②	③	③	④	③	⑤	④		⑤	
		8	①	①	①	②	②	③	③	④	④		④		⑤	
		8.5	①	①	①	②	②	③	③	⑤	④		⑤		⑤	
		9	①	①	①	②	②	④	③	⑤	④		⑤			
		9.5	①	①	①	②	②	④	③	⑤	④		⑤			
		10	①	①	②	③	③	④	④		⑤					
		11	①*	①*	②*	③*	③*	⑤*	④*		⑤*					
		12	①*	①*	②*	③*	③*	⑤*	④*							
		13	①*	②*	②*	④*	④*	⑤*	⑤*							
		14	①*	②*	②*	④*	④*		⑤*							
		15	①*	②*	③*	④*	④*									
		16	①*	②*	③*	④*	④*									
17	①*	②*	③*	⑤*	⑤*											
18	①*	②*	③*	⑤*	⑤*											
19	①*	②*	③*	⑤*	⑤*											
20	②*	③*	④*													
22	②*	③*	④*													
24																
26																
28																
30																
35																

配筋表：基礎梁の開口部（柱間隔）直下の補強筋《標準基礎》

【多雪区域（1.5m以下） 重い屋根 基礎幅150mm】 *印がついている場合：あばら筋を@200に変更が必要です。

《補強筋凡例》 ①：D13 ②：D13+D10 ③：2-D13 ④：D13+D16 ⑤：2-D16

※標準主筋が2-D13の場合、配筋表の①：D13、②：D13+D10は③：2-D13で置き換えてください。 ※黒塗りつぶし箇所は配筋の適用範囲外です。

基礎梁成 (mm)	階数	負担面積 (㎡)	柱間隔 (m) と開口部位置														
			0 < 柱間隔 ≤ 0.91		0.91 < 柱間隔 ≤ 1.82		1.82 < 柱間隔 ≤ 2.73		2.73 < 柱間隔 ≤ 3.64		3.64 < 柱間隔 ≤ 4.55		4.55 < 柱間隔 ≤ 5.46		5.46 < 柱間隔 ≤ 6.37		
			中央寄り	片側寄り	中央寄り	片側寄り	中央寄り	片側寄り	中央寄り	片側寄り	中央寄り	片側寄り	中央寄り	片側寄り	中央寄り	片側寄り	
900以上	平屋建て	1	①	①	①	①	①	①	①	①	①	①	①	①	①	①	
		1.5	①	①	①	①	①	①	①	①	①	①	①	①	①	①	
		2	①	①	①	①	①	①	①	①	①	①	①	①	①	①	
		2.5	①	①	①	①	①	①	①	①	①	①	①	①	①	①	
		3	①	①	①	①	①	①	①	①	①	①	①	①	①	②	
		3.5	①	①	①	①	①	①	①	①	①	①	①	①	②	①	②
		4	①	①	①	①	①	①	①	①	①	①	②	①	②	②	②
		4.5	①	①	①	①	①	①	①	①	①	①	②	①	②	②	③
		5	①	①	①	①	①	①	①	①	②	①	②	②	③	②	③
		5.5	①	①	①	①	①	①	①	①	②	②	②	②	③	②	④
		6	①	①	①	①	①	①	①	②	②	②	③	②	③	②	④
		6.5	①	①	①	①	①	②	①	②	②	③	②	④	③	④	④
		7	①	①	①	①	①	②	②	②	③	②	④	③	④	③	⑤
		7.5	①	①	①	①	①	②	②	③	②	④	③	④	⑤	③	⑤
		8	①	①	①	①	①	②	②	③	③	④	④	⑤	④	⑤	⑤
		8.5	①	①	①	①	①	②	②	③	③	④	④	⑤	④	⑤	⑤
		9	①	①	①	①	①	②	②	③	③	④	④	⑤	④	⑤	⑤
		9.5	①	①	①	②	②	③	③	④	④	⑤	④	⑤	④	⑤	⑤
		10	①	①	①	②	②	③	③	④	④	⑤	④	⑤	④	⑤	⑤
		11	①	①	①	②	②	③	③	④	④	⑤	④	⑤	④	⑤	⑤
		12	①	①	①	②	②	③	③	④	④	⑤	④	⑤	④	⑤	⑤
		13	①	①	①	②	②	④	③	⑤	④	⑤	④	⑤	④	⑤	⑤
		14	①	①	②	②	②	④	④	⑤	④	⑤	④	⑤	④	⑤	⑤
		15	①	*①	*②	*③	*③	*④	*④			⑤	*⑤				
		16	①	*①	*②	*③	*③	*⑤	*④			⑤	*⑤				
		17	①	*①	*②	*③	*③	*⑤	*④			⑤	*⑤				
		18	①	*①	*②	*③	*③	*⑤	*⑤								
		19	①	*②	*②	*④	*④	*⑤	*⑤								
		20	①	*②	*②	*④	*④	*⑤	*⑤								
		22	①	*②	*③	*④	*④										
	24	①	*②	*③	*⑤	*⑤											
	26	①	*②	*③	*⑤	*⑤											
	28	②	*②	*④	*⑤	*⑤											
	30	②	*③	*④													
	35																
900以上	2階建て	1	①	①	①	①	①	①	①	①	①	①	①	①	①	①	
		1.5	①	①	①	①	①	①	①	①	①	①	①	①	①	①	
		2	①	①	①	①	①	①	①	①	①	①	①	①	①	②	
		2.5	①	①	①	①	①	①	①	①	①	①	①	②	①	②	
		3	①	①	①	①	①	①	①	①	①	②	①	②	②	②	
		3.5	①	①	①	①	①	①	①	②	①	②	②	③	②	③	
		4	①	①	①	①	①	①	①	②	①	②	②	③	②	④	
		4.5	①	①	①	①	①	①	①	②	②	③	②	④	③	④	
		5	①	①	①	①	①	②	①	②	②	③	②	④	③	⑤	
		5.5	①	①	①	①	①	②	②	③	②	④	③	④	③	⑤	
		6	①	①	①	①	①	②	②	③	②	④	③	⑤	④	⑤	
		6.5	①	①	①	①	①	②	②	③	③	④	③	⑤	④	⑤	
		7	①	①	①	②	②	②	②	④	③	⑤	④	⑤	④	⑤	
		7.5	①	①	①	②	②	③	②	④	③	⑤	④	⑤	④	⑤	
		8	①	①	①	②	②	③	③	④	③	⑤	④	⑤	④	⑤	
		8.5	①	①	①	②	②	③	③	④	④	⑤	④	⑤	④	⑤	
		9	①	①	①	②	②	③	③	⑤	④	⑤	④	⑤	④	⑤	
		9.5	①	①	①	②	②	④	③	⑤	④	⑤	④	⑤	④	⑤	
		10	①	①	①	②	②	④	③	⑤	④	⑤	④	⑤	④	⑤	
		11	①	①	②	③	③	④	④	⑤	④	⑤	④	⑤	④	⑤	
		12	①	*①	*②	*③	*③	*⑤	*④			⑤	*⑤				
		13	①	*①	*②	*③	*③	*⑤	*④			⑤	*⑤				
		14	①	*②	*②	*④	*④	*⑤	*⑤								
		15	①	*②	*②	*④	*④	*⑤	*⑤								
		16	①	*②	*③	*④	*④										
17	①	*②	*③	*④	*④												
18	①	*②	*③	*⑤	*⑤												
19	①	*②	*③	*⑤	*⑤												
20	①	*②	*③	*⑤	*⑤												
22	②	*③	*④														
24	②	*③	*④														
26																	
28																	
30																	
35																	

配筋表：基礎梁の開口部（柱間隔）直下の補強筋《標準基礎》

尺モジュール

【多雪区域（1.5m以下） 重い屋根 基礎幅150mm】 *印がついている場合：あばら筋を@200に変更が必要です。

《補強筋凡例》 ①：D13 ②：D13+D10 ③：2-D13 ④：D13+D16 ⑤：2-D16

※標準主筋が2-D13の場合、配筋表の①：D13、②：D13+D10は③：2-D13で置き換えてください。 ※黒塗りつぶし箇所は配筋の適用範囲外です。

基礎梁成 (mm)	階数	負担面積 (㎡)	柱間隔 (m) と開口部位置													
			0 < 柱間隔 ≤ 0.91		0.91 < 柱間隔 ≤ 1.82		1.82 < 柱間隔 ≤ 2.73		2.73 < 柱間隔 ≤ 3.64		3.64 < 柱間隔 ≤ 4.55		4.55 < 柱間隔 ≤ 5.46		5.46 < 柱間隔 ≤ 6.37	
			中央寄り	片側寄り	中央寄り	片側寄り	中央寄り	片側寄り	中央寄り	片側寄り	中央寄り	片側寄り	中央寄り	片側寄り	中央寄り	片側寄り
950以上	平屋建て	1	①	①	①	①	①	①	①	①	①	①	①	①	①	①
		1.5	①	①	①	①	①	①	①	①	①	①	①	①	①	①
		2	①	①	①	①	①	①	①	①	①	①	①	①	①	①
		2.5	①	①	①	①	①	①	①	①	①	①	①	①	①	①
		3	①	①	①	①	①	①	①	①	①	①	①	①	①	②
		3.5	①	①	①	①	①	①	①	①	①	①	①	②	①	②
		4	①	①	①	①	①	①	①	①	①	②	①	②	①	②
		4.5	①	①	①	①	①	①	①	①	①	②	②	②	②	③
		5	①	①	①	①	①	①	①	②	①	②	②	②	②	③
		5.5	①	①	①	①	①	①	①	②	②	①	②	②	③	③
		6	①	①	①	①	①	①	①	②	②	②	②	③	②	④
		6.5	①	①	①	①	①	②	①	②	②	③	②	④	③	④
		7	①	①	①	①	①	②	①	②	②	③	②	④	③	④
		7.5	①	①	①	①	①	②	②	②	②	③	②	④	③	⑤
		8	①	①	①	①	①	②	②	③	②	④	③	④	③	⑤
		8.5	①	①	①	①	①	②	②	③	②	④	③	⑤	④	⑤
		9	①	①	①	①	①	②	②	③	②	④	③	⑤	④	
		9.5	①	①	①	①	①	②	②	③	③	④	③	⑤	④	
		10	①	①	①	②	②	②	②	④	③	⑤	④	⑤	④	
		11	①	①	①	②	②	③	②	④	③	⑤	④		⑤	
		12	①	①	①	②	②	③	③	④	④	⑤	④		⑤	
		13	①	①	①	②	②	④	③	⑤	④		⑤			
		14	①	①	①	②	②	④	③	⑤	④		⑤			
		15	①	①	②	②	②	④	④	⑤	⑤		⑤			
		16	①*	①*	②*	③*	③*	④*	④*		⑤*					
		17	①*	①*	②*	③*	③*	⑤*	④*		⑤*					
		18	①*	①*	②*	③*	③*	⑤*	④*		⑤*					
		19	①*	①*	②*	③*	③*	⑤*	⑤*							
		20	①*	②*	②*	④*	④*	⑤*	⑤*							
		22	①*	②*	②*	④*	④*		⑤*							
	24	①*	②*	③*	④*	④*										
	26	①*	②*	③*	⑤*	⑤*										
	28	①*	②*	③*	⑤*	⑤*										
	30	②*	②*	④*	⑤*	⑤*										
	35															
950以上	2階建て	1	①	①	①	①	①	①	①	①	①	①	①	①	①	
		1.5	①	①	①	①	①	①	①	①	①	①	①	①	①	
		2	①	①	①	①	①	①	①	①	①	①	①	①	①	
		2.5	①	①	①	①	①	①	①	①	①	①	②	①	②	
		3	①	①	①	①	①	①	①	①	①	②	①	②	①	②
		3.5	①	①	①	①	①	①	①	①	①	②	①	②	②	③
		4	①	①	①	①	①	①	①	②	①	②	②	③	②	③
		4.5	①	①	①	①	①	①	①	②	②	②	③	②	③	④
		5	①	①	①	①	①	②	①	②	②	③	②	④	③	④
		5.5	①	①	①	①	①	②	②	②	②	③	②	④	③	⑤
		6	①	①	①	①	①	②	②	③	②	④	③	④	③	⑤
		6.5	①	①	①	①	①	②	②	③	②	④	③	⑤	④	
		7	①	①	①	①	①	②	②	③	③	④	③	⑤	④	
		7.5	①	①	①	②	②	②	②	④	③	⑤	④	⑤	④	
		8	①	①	①	②	②	③	②	④	③	⑤	④		⑤	
		8.5	①	①	①	②	②	③	③	④	③	⑤	④		⑤	
		9	①	①	①	②	②	③	③	④	④	⑤	④		⑤	
		9.5	①	①	①	②	②	③	③	⑤	④		⑤		⑤	
		10	①	①	①	②	②	④	③	⑤	④		⑤			
		11	①	①	②	②	②	④	④	⑤	④		⑤			
		12	①*	①*	②*	③*	③*	④*	④*		⑤*					
		13	①*	①*	②*	③*	③*	⑤*	④*		⑤*					
		14	①*	①*	②*	③*	③*	⑤*	⑤*							
		15	①*	②*	②*	④*	④*	⑤*	⑤*							
		16	①*	②*	②*	④*	④*		⑤*							
17	①*	②*	③*	④*	④*											
18	①*	②*	③*	④*	④*											
19	①*	②*	③*	⑤*	⑤*											
20	①*	②*	③*	⑤*	⑤*											
22	②*	②*	④*	⑤*	⑤*											
24	②*	③*	④*													
26																
28																
30																
35																

配筋表：基礎梁の開口部（柱間隔）直下の補強筋《標準基礎》

【多雪区域（1.5m以下） 重い屋根 基礎幅150mm】 *印がついている場合：あばら筋を@200に変更が必要です。

《補強筋凡例》 ①：D13 ②：D13+D10 ③：2-D13 ④：D13+D16 ⑤：2-D16

※標準主筋が2-D13の場合、配筋表の①：D13、②：D13+D10は③：2-D13で置き換えてください。※黒塗りつぶし箇所は配筋の適用範囲外です。

基礎梁成 (mm)	階数	負担面積 (㎡)	柱間隔 (m) と開口部位置													
			0 < 柱間隔 ≤ 0.91		0.91 < 柱間隔 ≤ 1.82		1.82 < 柱間隔 ≤ 2.73		2.73 < 柱間隔 ≤ 3.64		3.64 < 柱間隔 ≤ 4.55		4.55 < 柱間隔 ≤ 5.46		5.46 < 柱間隔 ≤ 6.37	
			中央寄り	片側寄り	中央寄り	片側寄り	中央寄り	片側寄り	中央寄り	片側寄り	中央寄り	片側寄り	中央寄り	片側寄り	中央寄り	片側寄り
1000以上	平屋建て	1	①	①	①	①	①	①	①	①	①	①	①	①	①	①
		1.5	①	①	①	①	①	①	①	①	①	①	①	①	①	①
		2	①	①	①	①	①	①	①	①	①	①	①	①	①	①
		2.5	①	①	①	①	①	①	①	①	①	①	①	①	①	①
		3	①	①	①	①	①	①	①	①	①	①	①	①	①	②
		3.5	①	①	①	①	①	①	①	①	①	①	①	②	①	②
		4	①	①	①	①	①	①	①	①	①	①	①	②	①	②
		4.5	①	①	①	①	①	①	①	①	①	②	①	②	②	②
		5	①	①	①	①	①	①	①	①	①	②	②	②	②	③
		5.5	①	①	①	①	①	①	①	②	①	②	②	③	②	③
		6	①	①	①	①	①	①	①	②	②	①	②	③	②	④
		6.5	①	①	①	①	①	①	①	②	③	②	③	③	②	④
		7	①	①	①	①	①	①	②	②	③	②	③	④	③	④
		7.5	①	①	①	①	①	②	②	③	③	③	④	④	③	④
		8	①	①	①	①	①	②	③	③	④	④	⑤	④	④	⑤
		8.5	①	①	①	①	①	②	③	④	④	⑤	④	④	④	⑤
		9	①	①	①	①	①	②	③	④	⑤	④	⑤	⑤	④	⑤
	9.5	①	①	①	①	①	②	③	④	⑤	④	⑤	⑤	④		
	10	①	①	①	①	①	②	③	④	⑤	④	⑤	⑤	④		
	11	①	①	①	②	②	③	④	⑤	④	⑤	④		④		
	12	①	①	①	②	②	③	④	⑤	④	⑤	④		⑤		
	13	①	①	①	②	②	③	④	⑤	④		④		⑤		
	14	①	①	①	②	②	④	③	⑤	④		⑤				
	15	①	①	①	②	②	④	③	⑤	④		⑤				
	16	①	①	②	③	③	④	④	⑤	⑤		⑤				
	17	①*	①*	②*	③*	③*	④*	④*		⑤*						
	18	①*	①*	②*	③*	③*	⑤*	④*		⑤*						
	19	①*	①*	②*	③*	③*	⑤*	④*		⑤*						
	20	①*	①*	②*	③*	③*	⑤*	⑤*								
	22	①*	②*	②*	④*	④*		⑤*								
	24	①*	②*	③*	④*	④*		⑤*								
	26	①*	②*	③*	④*	④*										
	28	①*	②*	③*	⑤*	⑤*										
	30	①*	②*	③*	⑤*	⑤*										
	35	②*	③*	④*												
2階建て	1	①	①	①	①	①	①	①	①	①	①	①	①	①	①	
	1.5	①	①	①	①	①	①	①	①	①	①	①	①	①	①	
	2	①	①	①	①	①	①	①	①	①	①	①	①	①	①	
	2.5	①	①	①	①	①	①	①	①	①	①	①	①	①	②	
	3	①	①	①	①	①	①	①	①	①	①	①	②	①	②	
	3.5	①	①	①	①	①	①	①	①	①	②	①	②	②	③	
	4	①	①	①	①	①	①	①	②	①	②	②	③	②	③	
	4.5	①	①	①	①	①	①	①	②	①	②	②	③	②	④	
	5	①	①	①	①	①	①	①	②	②	③	②	③	②	④	
	5.5	①	①	①	①	①	②	①	②	②	③	②	④	③	④	
	6	①	①	①	①	①	②	②	③	②	③	③	④	③	⑤	
	6.5	①	①	①	①	①	②	②	③	②	④	③	④	③	⑤	
	7	①	①	①	①	①	②	②	③	②	④	③	⑤	④		
	7.5	①	①	①	①	①	②	②	③	③	④	③	⑤	④		
	8	①	①	①	②	②	③	②	④	③	⑤	④		④		
	8.5	①	①	①	②	②	③	②	④	③	⑤	④		⑤		
	9	①	①	①	②	②	③	③	④	③	⑤	④		⑤		
	9.5	①	①	①	②	②	③	③	④	④	⑤	④		⑤		
10	①	①	①	②	②	③	③	⑤	④		⑤		⑤			
11	①	①	①	②	②	④	③	⑤	④		⑤					
12	①	①	②	③	③	④	④		⑤							
13	①*	①*	②*	③*	③*	④*	④*		⑤*							
14	①*	①*	②*	③*	③*	⑤*	④*		⑤*							
15	①*	①*	②*	③*	③*	⑤*	⑤*									
16	①*	②*	②*	④*	④*		⑤*									
17	①*	②*	②*	④*	④*		⑤*									
18	①*	②*	③*	④*	④*											
19	①*	②*	③*	④*	④*											
20	①*	②*	③*	⑤*	⑤*											
22	①*	②*	③*	⑤*	⑤*											
24	②*	③*	④*													
26	②*	③*	④*													
28																
30																
35																

配筋表：基礎梁の開口部（柱間隔）直下の補強筋《 地中梁 》

【 多雪区域（1.5m以下） 重い屋根 】

《 補強筋凡例 》 ①：1-D13(15) ②：2-D13(縦)(15) ③：2-D13(横)(25) ④：3-D13(30)
 ⑤：4-D13(35) ⑥：5-D13(40) ⑦：6-D13(45) ⑧：7-D13(50)

※標準主筋をD13とする場合は下記スパン表内の②：2-D13（縦）（15）は③：2-D13（横）（25）に置き換える ※黒塗りつぶし箇所は配筋の適用範囲外です。

基礎梁成 (mm)	階数	負担面積 (㎡)	柱間隔 (m) と開口部位置													
			0 < 柱間隔 ≤ 0.91		0.91 < 柱間隔 ≤ 1.82		1.82 < 柱間隔 ≤ 2.73		2.73 < 柱間隔 ≤ 3.64		3.64 < 柱間隔 ≤ 4.55		4.55 < 柱間隔 ≤ 5.46		5.46 < 柱間隔 ≤ 6.37	
			中央寄り	片側寄り	中央寄り	片側寄り	中央寄り	片側寄り	中央寄り	片側寄り	中央寄り	片側寄り	中央寄り	片側寄り	中央寄り	片側寄り
190以上	平屋建て	1	①	①	①	③	③	④	④	⑥	⑤	⑦	⑥		⑦	
		1.5	③	③	③	④	④	⑥	⑥		⑦					
		2	③	③	④	⑥	⑥		⑧							
		2.5	④	④	⑤	⑦	⑦									
		3	⑤	⑤	⑥											
		3.5	⑥	⑥	⑦											
		4	⑧	⑧	⑧											
		4.5														
		5														
		5.5														
		6														
		6.5														
		7														
		7.5														
		8														
	8.5															
	9															
	9.5															
	10															
	11															
	12															
	13															
	14															
	15															
	16															
	17															
	18															
	19															
	20															
	22															
	24															
	26															
	28															
	30															
	35															
2階建て	1	③	③	③	④	④	⑥	⑤	⑧	⑥		⑧				
	1.5	③	③	④	⑥	⑥		⑧								
	2	⑤	⑤	⑤	⑧	⑧										
	2.5	⑥	⑥	⑥												
	3	⑧	⑧	⑧												
	3.5															
	4															
	4.5															
	5															
	5.5															
	6															
	6.5															
	7															
	7.5															
	8															
	8.5															
	9															
	9.5															
	10															
	11															
12																
13																
14																
15																
16																
17																
18																
19																
20																
22																
24																
26																
28																
30																
35																

配筋表：基礎梁の開口部（柱間隔）直下の補強筋《 地中梁 》

【 多雪区域（1.5m以下） 重い屋根 】

《 補強筋凡例 》 ①：1-D13(15) ②：2-D13(縦)(15) ③：2-D13(横)(25) ④：3-D13(30)
 ⑤：4-D13(35) ⑥：5-D13(40) ⑦：6-D13(45) ⑧：7-D13(50)

※標準主筋をD13とする場合は下記スパン表内の②：2-D13（縦）（15）は③：2-D13（横）（25）に置き換える ※黒塗りつぶし箇所は配筋の適用範囲外です。

基礎梁成 (mm)	階数	負担面積 (㎡)	柱間隔 (m) と開口部位置													
			0 < 柱間隔 ≤ 0.91		0.91 < 柱間隔 ≤ 1.82		1.82 < 柱間隔 ≤ 2.73		2.73 < 柱間隔 ≤ 3.64		3.64 < 柱間隔 ≤ 4.55		4.55 < 柱間隔 ≤ 5.46		5.46 < 柱間隔 ≤ 6.37	
			中央寄り	片側寄り	中央寄り	片側寄り	中央寄り	片側寄り	中央寄り	片側寄り	中央寄り	片側寄り	中央寄り	片側寄り	中央寄り	片側寄り
210 以上	平屋建て	1	①	①	①	①	①	③	③	④	③	⑤	④	⑥	⑤	⑦
		1.5	①	①	①	③	③	④	④	⑥	⑤	⑧	⑥		⑦	
		2	①	①	③	④	④	⑥	⑤	⑧	⑦		⑧			
		2.5	③	③	③	⑤	⑤	⑧	⑦		⑧					
		3	③	③	④	⑥	⑥		⑧							
		3.5	④	④	④	⑦	⑦									
		4	④	④	⑤	⑧	⑧									
		4.5	⑤	⑤	⑥											
		5	⑥	⑥	⑦											
		5.5	⑥	⑥	⑦											
		6	⑦	⑦	⑧											
		6.5	⑧	⑧												
		7														
		7.5														
		8														
	8.5															
	9															
	9.5															
	10															
	11															
	12															
	13															
	14															
	15															
	16															
	17															
	18															
	19															
	20															
	22															
	24															
	26															
	28															
	30															
	35															
210 以上	2階建て	1	①	①	①	③	③	④	③	⑤	④	⑦	⑤	⑧	⑥	
		1.5	①	①	③	④	④	⑥	⑤	⑧	⑦		⑧			
		2	③	③	③	⑤	⑤	⑧	⑦							
		2.5	③	③	④	⑦	⑦									
		3	④	④	⑤	⑧	⑧									
		3.5	⑤	⑤	⑥											
		4	⑥	⑥	⑦											
		4.5	⑦	⑦	⑧											
		5	⑧	⑧												
		5.5														
		6														
		6.5														
		7														
		7.5														
		8														
		8.5														
		9														
		9.5														
		10														
		11														
12																
13																
14																
15																
16																
17																
18																
19																
20																
22																
24																
26																
28																
30																
35																

配筋表：基礎梁の開口部（柱間隔）直下の補強筋《 地中梁 》

【 多雪区域（1.5m以下） 重い屋根 】

《 補強筋凡例 》 ①：1-D13(15) ②：2-D13(縦)(15) ③：2-D13(横)(25) ④：3-D13(30)
 ⑤：4-D13(35) ⑥：5-D13(40) ⑦：6-D13(45) ⑧：7-D13(50)

※標準主筋をD13とする場合は下記スパン表内の②：2-D13（縦）（15）は③：2-D13（横）（25）に置き換える ※黒塗りつぶし箇所は配筋の適用範囲外です。

基礎梁成 (mm)	階数	負担面積 (㎡)	柱間隔 (m) と開口部位置														
			0 < 柱間隔 ≤ 0.91		0.91 < 柱間隔 ≤ 1.82		1.82 < 柱間隔 ≤ 2.73		2.73 < 柱間隔 ≤ 3.64		3.64 < 柱間隔 ≤ 4.55		4.55 < 柱間隔 ≤ 5.46		5.46 < 柱間隔 ≤ 6.37		
			中央寄り	片側寄り	中央寄り	片側寄り	中央寄り	片側寄り	中央寄り	片側寄り	中央寄り	片側寄り	中央寄り	片側寄り	中央寄り	片側寄り	
250以上	平屋建て	1	①	①	①	①	①	①	③	③	③	③	④	③	⑤	④	⑥
		1.5	①	①	①	③	③	③	④	③	⑤	④	⑦	⑤	⑧	⑥	
		2	①	①	③	③	③	④	⑤	⑦	④	⑥	⑦	⑦	⑧	⑧	
		2.5	①	①	③	③	③	⑤	④	⑥	⑤	⑧	⑥		⑧		
		3	③	③	③	④	④	⑥	⑤	⑧	⑥		⑧				
		3.5	③	③	③	④	④	⑦	⑥		⑧						
		4	③	③	③	⑤	⑤	⑧	⑦								
		4.5	③	③	④	⑥	⑥		⑧								
		5	④	④	④	⑥	⑥										
		5.5	④	④	⑤	⑦	⑦										
		6	⑤	⑤	⑤	⑧	⑧										
		6.5	⑤	⑤	⑥												
		7	⑥	⑥	⑥												
		7.5	⑥	⑥	⑥												
		8	⑦	⑦	⑦												
	8.5	⑧	⑧	⑧													
	9	⑧	⑧	⑧													
	9.5																
	10																
	11																
	12																
	13																
	14																
	15																
	16																
	17																
	18																
	19																
	20																
	22																
	24																
	26																
	28																
	30																
	35																
2階建て	1	①	①	①	①	①	③	③	③	③	④	③	⑤	④	⑥		
	1.5	①	①	①	③	③	④	③	⑤	④	⑦	⑤	⑧	⑥			
	2	①	①	③	③	③	⑤	⑤	⑦	⑥	⑦	⑦	⑧	⑧			
	2.5	③	③	③	④	④	⑦	⑥		⑦							
	3	③	③	③	⑤	⑤	⑧	⑦									
	3.5	③	③	④	⑥	⑥		⑧									
	4	④	④	⑤	⑦	⑦											
	4.5	⑤	⑤	⑤	⑧	⑧											
	5	⑥	⑥	⑥													
	5.5	⑥	⑥	⑥													
	6	⑦	⑦	⑦													
	6.5	⑧	⑧	⑧													
	7	⑧	⑧	⑧													
	7.5																
	8																
	8.5																
	9																
	9.5																
	10																
	11																
12																	
13																	
14																	
15																	
16																	
17																	
18																	
19																	
20																	
22																	
24																	
26																	
28																	
30																	
35																	

配筋表：基礎梁の開口部（柱間隔）直下の補強筋《 地中梁 》

【 多雪区域（1.5m以下） 重い屋根 】

《 補強筋凡例 》 ①：1-D13(15) ②：2-D13(縦)(15) ③：2-D13(横)(25) ④：3-D13(30)
 ⑤：4-D13(35) ⑥：5-D13(40) ⑦：6-D13(45) ⑧：7-D13(50)

※標準主筋をD13とする場合は下記スパン表内の②：2-D13（縦）（15）は③：2-D13（横）（25）に置き換える ※黒塗りつぶし箇所は配筋の適用範囲外です。

基礎梁成 (mm)	階数	負担面積 (㎡)	柱間隔 (m) と開口部位置													
			0 < 柱間隔 ≤ 0.91		0.91 < 柱間隔 ≤ 1.82		1.82 < 柱間隔 ≤ 2.73		2.73 < 柱間隔 ≤ 3.64		3.64 < 柱間隔 ≤ 4.55		4.55 < 柱間隔 ≤ 5.46		5.46 < 柱間隔 ≤ 6.37	
			中央寄り	片側寄り	中央寄り	片側寄り	中央寄り	片側寄り	中央寄り	片側寄り	中央寄り	片側寄り	中央寄り	片側寄り	中央寄り	片側寄り
290以上	平屋建て	1	①	①	①	①	①	①	①	①	①	②	①	③	②	③
		1.5	①	①	①	①	①	②	①	③	②	③	③	④	③	⑤
		2	①	①	①	①	①	③	②	④	③	④	④	⑤	④	⑥
		2.5	①	①	①	②	②	③	③	④	④	⑤	④	⑦	⑤	⑧
		3	①	①	①	③	③	④	④	⑤	④	⑦	⑤	⑧	⑥	
		3.5	①	①	②	③	③	⑤	④	⑥	⑤	⑧	⑥		⑦	
		4	①	①	②	④	④	⑤	⑤	⑦	⑥		⑦		⑧	
		4.5	①	②	③	④	④	⑥	⑤	⑧	⑦		⑧			
		5	①	②	③	④	④	⑦	⑥		⑦					
		5.5	①	②	③	⑤	⑤	⑦	⑥		⑧					
		6	④	④	④	⑤	⑤	⑧	⑦							
		6.5	④	④	④	⑥	⑥		⑧							
		7	④	④	④	⑥	⑥		⑧							
		7.5	⑤	⑤	⑤	⑦	⑦									
		8	⑤	⑤	⑤	⑦	⑦									
	8.5	⑥	⑥	⑥	⑦	⑦										
	9	⑥	⑥	⑥	⑧	⑧										
	9.5	⑥	⑥	⑥	⑧	⑧										
	10	⑦	⑦	⑦												
	11	⑧	⑧	⑧												
	12															
	13															
	14															
	15															
	16															
	17															
	18															
	19															
	20															
	22															
	24															
	26															
	28															
	30															
	35															
290以上	2階建て	1	①	①	①	①	①	①	①	②	②	③	②	④	③	④
		1.5	①	①	①	①	①	③	②	④	③	④	④	⑤	④	⑥
		2	①	①	①	②	②	④	③	⑤	④	⑥	⑤	⑦	⑤	⑧
		2.5	①	①	②	③	③	④	④	⑥	⑤	⑦	⑥		⑦	
		3	①	①	②	④	④	⑤	⑤	⑦	⑥		⑦		⑧	
		3.5	①	②	③	④	④	⑥	⑤	⑧	⑦		⑧			
		4	①	②	③	⑤	⑤	⑦	⑥		⑧					
		4.5	④	④	④	⑤	⑤	⑧	⑦							
		5	④	④	④	⑥	⑥		⑧							
		5.5	⑤	⑤	⑤	⑥	⑥									
		6	⑤	⑤	⑤	⑦	⑦									
		6.5	⑥	⑥	⑥	⑧	⑧									
		7	⑥	⑥	⑥	⑧	⑧									
		7.5	⑦	⑦	⑦											
		8	⑦	⑦	⑦											
	8.5	⑧	⑧	⑧												
	9															
	9.5															
	10															
	11															
12																
13																
14																
15																
16																
17																
18																
19																
20																
22																
24																
26																
28																
30																
35																

配筋表：基礎梁の開口部（柱間隔）直下の補強筋《 地中梁 》

【 多雪区域（1.5m以下） 重い屋根 】

《 補強筋凡例 》 ①：1-D13(15) ②：2-D13(縦)(15) ③：2-D13(横)(25) ④：3-D13(30)
 ⑤：4-D13(35) ⑥：5-D13(40) ⑦：6-D13(45) ⑧：7-D13(50)

※標準主筋をD13とする場合は下記スパン表内の②：2-D13（縦）（15）は③：2-D13（横）（25）に置き換える ※黒塗りつぶし箇所は配筋の適用範囲外です。

基礎梁成 (mm)	階数	負担面積 (㎡)	柱間隔 (m) と開口部位置													
			0 < 柱間隔 ≤ 0.91		0.91 < 柱間隔 ≤ 1.82		1.82 < 柱間隔 ≤ 2.73		2.73 < 柱間隔 ≤ 3.64		3.64 < 柱間隔 ≤ 4.55		4.55 < 柱間隔 ≤ 5.46		5.46 < 柱間隔 ≤ 6.37	
			中央寄り	片側寄り	中央寄り	片側寄り	中央寄り	片側寄り	中央寄り	片側寄り	中央寄り	片側寄り	中央寄り	片側寄り	中央寄り	片側寄り
350以上	平屋建て	1	①	①	①	①	①	①	①	①	①	①	①	②	①	②
		1.5	①	①	①	①	①	①	①	②	①	②	②	②	②	③
		2	①	①	①	①	①	②	①	②	②	③	②	④	③	④
		2.5	①	①	①	①	①	②	②	③	②	④	③	④	④	⑤
		3	①	①	①	②	②	②	②	④	③	④	④	⑤	④	⑥
		3.5	①	①	①	②	②	③	③	④	④	⑤	④	⑥	④	⑦
		4	①	①	①	②	②	④	③	④	④	⑤	④	⑦	⑤	⑧
		4.5	①	①	②	②	②	④	④	⑤	④	⑥	⑤	⑦	⑥	
		5	①	①	②	③	③	④	④	⑤	⑤	⑦	⑤	⑧	⑥	
		5.5	①	①	②	③	③	⑤	④	⑥	⑤	⑦	⑥		⑦	
		6	①	②	②	④	④	⑤	④	⑦	⑤	⑧	⑦		⑧	
		6.5	①	②	②	④	④	⑤	⑤	⑦	⑥		⑦		⑧	
		7	①	②	③	④	④	⑥	⑤	⑧	⑥		⑧			
		7.5	①	②	③	④	④	⑥	⑤	⑧	⑦		⑧			
		8	④	④	④	④	④	⑦	⑥		⑦					
	8.5	④	④	④	⑤	⑤	⑦	⑥		⑧						
	9	④	④	④	⑤	⑤	⑦	⑦		⑧						
	9.5	⑤	⑤	⑤	⑤	⑤	⑧	⑦								
	10	⑤	⑤	⑤	⑤	⑤	⑧	⑦								
	11	⑥	⑥	⑥	⑥	⑥		⑧								
	12	⑥	⑥	⑥	⑦	⑦										
	13	⑦	⑦	⑦	⑦	⑦										
	14	⑦	⑦	⑦	⑧	⑧										
	15	⑧	⑧	⑧	⑧	⑧										
	16															
	17															
	18															
	19															
	20															
	22															
	24															
	26															
	28															
	30															
	35															
2階建て	1	①	①	①	①	①	①	①	①	①	②	①	②	②	③	
	1.5	①	①	①	①	①	②	①	②	②	③	②	④	③	④	
	2	①	①	①	①	①	②	②	③	②	④	③	④	④	⑤	
	2.5	①	①	①	②	②	③	②	④	③	⑤	④	⑤	④	⑥	
	3	①	①	①	②	②	④	③	④	④	⑤	④	⑦	⑤	⑧	
	3.5	①	①	②	③	③	④	④	⑤	④	⑥	⑤	⑧	⑥		
	4	①	①	②	③	③	④	④	⑥	⑤	⑦	⑥		⑦		
	4.5	①	②	②	④	④	⑤	④	⑦	⑤	⑧	⑦		⑧		
	5	①	②	②	④	④	⑤	⑤	⑦	⑥		⑦		⑧		
	5.5	①	②	③	④	④	⑥	⑤	⑧	⑦		⑧				
	6	④	④	④	④	④	⑦	⑥		⑦						
	6.5	④	④	④	⑤	⑤	⑦	⑥		⑧						
	7	④	④	④	⑤	⑤	⑧	⑦		⑧						
	7.5	⑤	⑤	⑤	⑤	⑤	⑧	⑦								
	8	⑤	⑤	⑤	⑥	⑥		⑧								
	8.5	⑥	⑥	⑥	⑥	⑥		⑧								
	9	⑥	⑥	⑥	⑦	⑦										
	9.5	⑦	⑦	⑦	⑦	⑦										
	10	⑦	⑦	⑦	⑦	⑦										
	11	⑧	⑧	⑧	⑧	⑧										
12																
13																
14																
15																
16																
17																
18																
19																
20																
22																
24																
26																
28																
30																
35																

配筋表：基礎梁の開口部（柱間隔）直下の補強筋《 地中梁 》

【 多雪区域（1.5m以下） 重い屋根 】

《 補強筋凡例 》 ①：1-D13(15) ②：2-D13(縦)(15) ③：2-D13(横)(25) ④：3-D13(30)
 ⑤：4-D13(35) ⑥：5-D13(40) ⑦：6-D13(45) ⑧：7-D13(50)

※標準主筋をD13とする場合は下記スパン表内の②：2-D13（縦）（15）は③：2-D13（横）（25）に置き換える ※黒塗りつぶし箇所は配筋の適用範囲外です。

基礎梁成 (mm)	階数	負担面積 (㎡)	柱間隔 (m) と開口部位置													
			0 < 柱間隔 ≤ 0.91		0.91 < 柱間隔 ≤ 1.82		1.82 < 柱間隔 ≤ 2.73		2.73 < 柱間隔 ≤ 3.64		3.64 < 柱間隔 ≤ 4.55		4.55 < 柱間隔 ≤ 5.46		5.46 < 柱間隔 ≤ 6.37	
			中央寄り	片側寄り	中央寄り	片側寄り	中央寄り	片側寄り	中央寄り	片側寄り	中央寄り	片側寄り	中央寄り	片側寄り	中央寄り	片側寄り
400以上	平屋建て	1	①	①	①	①	①	①	①	①	①	①	①	①	①	②
		1.5	①	①	①	①	①	①	①	①	①	②	①	②	②	②
		2	①	①	①	①	①	①	①	②	①	②	②	②	②	④
		2.5	①	①	①	①	①	②	①	②	②	②	②	④	②	④
		3	①	①	①	①	①	②	②	②	②	④	②	④	④	⑤
		3.5	①	①	①	②	②	②	②	④	②	④	④	⑤	④	⑤
		4	①	①	①	②	②	②	②	④	③	④	④	⑤	④	⑥
		4.5	①	①	①	②	②	③	②	④	④	⑤	④	⑤	⑤	⑥
		5	①	①	①	②	②	④	③	④	④	⑤	④	⑥	⑤	⑦
		5.5	①	①	②	②	②	④	④	⑤	④	⑥	⑤	⑦	⑤	⑧
		6	①	①	②	②	②	④	④	⑤	④	⑥	⑤	⑦	⑥	⑧
		6.5	①	①	②	③	③	④	④	⑤	⑤	⑥	⑤	⑧	⑥	
		7	①	②	②	④	④	⑤	④	⑥	⑤	⑦	⑥	⑧	⑥	
		7.5	①	②	②	④	④	⑤	④	⑥	⑤	⑦	⑥		⑦	
		8	①	②	②	④	④	⑤	⑤	⑥	⑤	⑧	⑥		⑦	
		8.5	①	②	②	④	④	⑤	⑤	⑦	⑥	⑧	⑦		⑧	
		9	①	②	②	④	④	⑤	⑤	⑦	⑥		⑦		⑧	
		9.5	④	④	④	④	④	⑥	⑤	⑦	⑥		⑦			
	10	④	④	④	④	④	⑥	⑤	⑧	⑦		⑧				
	11	④	④	④	⑤	⑤	⑦	⑥		⑦						
	12	⑤	⑤	⑤	⑤	⑤	⑦	⑥		⑧						
	13	⑤	⑤	⑤	⑤	⑤	⑧	⑦								
	14	⑥	⑥	⑥	⑥	⑥	⑧	⑦								
	15	⑥	⑥	⑥	⑥	⑥		⑧								
	16	⑦	⑦	⑦	⑦	⑦		⑧								
	17	⑧	⑧	⑧	⑧	⑧										
	18	⑧	⑧	⑧	⑧	⑧										
	19															
	20															
	22															
	24															
	26															
	28															
	30															
	35															
2階建て	1	①	①	①	①	①	①	①	①	①	①	②	①	②		
	1.5	①	①	①	①	①	①	①	②	①	②	②	②	④		
	2	①	①	①	①	①	②	②	②	②	③	②	④	②	④	
	2.5	①	①	①	①	①	②	②	③	②	④	③	④	④	⑤	
	3	①	①	①	②	②	②	②	④	③	④	④	⑤	④	⑥	
	3.5	①	①	①	②	②	④	②	④	④	⑤	④	⑥	⑤	⑥	
	4	①	①	②	②	②	④	④	⑤	④	⑤	⑤	⑥	⑤	⑦	
	4.5	①	①	②	②	②	④	④	⑤	④	⑥	⑤	⑦	⑥	⑧	
	5	①	①	②	③	③	④	④	⑤	⑤	⑦	⑤	⑧	⑥		
	5.5	①	②	②	④	④	⑤	④	⑥	⑤	⑦	⑥		⑦		
	6	①	②	②	④	④	⑤	⑤	⑥	⑤	⑧	⑥		⑦		
	6.5	①	②	②	④	④	⑤	⑤	⑦	⑥		⑦		⑧		
	7	①	②	②	④	④	⑥	⑤	⑦	⑥		⑦				
	7.5	④	④	④	④	④	⑥	⑤	⑧	⑦		⑧				
	8	④	④	④	⑤	⑤	⑥	⑥	⑧	⑦		⑧				
	8.5	⑤	⑤	⑤	⑤	⑤	⑦	⑥		⑦						
	9	⑤	⑤	⑤	⑤	⑤	⑦	⑥		⑧						
9.5	⑤	⑤	⑤	⑤	⑤	⑧	⑦		⑧							
10	⑥	⑥	⑥	⑥	⑥	⑧	⑦									
11	⑥	⑥	⑥	⑥	⑥		⑧									
12	⑦	⑦	⑦	⑦	⑦		⑧									
13	⑧	⑧	⑧	⑧	⑧											
14	⑧	⑧	⑧	⑧	⑧											
15																
16																
17																
18																
19																
20																
22																
24																
26																
28																
30																
35																

配筋表：基礎梁の開口部（柱間隔）直下の補強筋《 地中梁 》

【 多雪区域（1.5m以下） 重い屋根 】

《 補強筋凡例 》 ①：1-D13(15) ②：2-D13(縦)(15) ③：2-D13(横)(25) ④：3-D13(30)
 ⑤：4-D13(35) ⑥：5-D13(40) ⑦：6-D13(45) ⑧：7-D13(50)

※標準主筋をD13とする場合は下記スパン表内の②：2-D13（縦）（15）は③：2-D13（横）（25）に置き換える ※黒塗りつぶし箇所は配筋の適用範囲外です。

基礎梁成 (mm)	階数	負担面積 (㎡)	柱間隔 (m) と開口部位置														
			0 < 柱間隔 ≤ 0.91		0.91 < 柱間隔 ≤ 1.82		1.82 < 柱間隔 ≤ 2.73		2.73 < 柱間隔 ≤ 3.64		3.64 < 柱間隔 ≤ 4.55		4.55 < 柱間隔 ≤ 5.46		5.46 < 柱間隔 ≤ 6.37		
			中央寄り	片側寄り	中央寄り	片側寄り	中央寄り	片側寄り	中央寄り	片側寄り	中央寄り	片側寄り	中央寄り	片側寄り	中央寄り	片側寄り	
450以上	平屋建て	1	①	①	①	①	①	①	①	①	①	①	①	①	①	①	
		1.5	①	①	①	①	①	①	①	①	①	①	①	①	②	①	②
		2	①	①	①	①	①	①	①	②	①	②	②	②	②	②	②
		2.5	①	①	①	①	①	①	①	②	②	②	②	②	②	②	④
		3	①	①	①	①	①	②	②	②	②	②	②	②	④	②	④
		3.5	①	①	①	①	①	②	②	②	②	④	②	④	②	④	⑤
		4	①	①	①	②	②	②	②	④	②	④	④	⑤	④	⑤	⑤
		4.5	①	①	①	②	②	②	②	④	②	④	④	⑤	④	⑤	⑤
		5	①	①	①	②	②	②	②	④	④	⑤	④	⑤	④	⑤	⑥
		5.5	①	①	①	②	②	②	④	②	④	④	⑤	④	⑥	⑤	⑥
		6	①	①	②	②	②	④	④	⑤	④	⑤	⑤	⑥	⑤	⑦	⑦
		6.5	①	①	②	②	②	④	④	⑤	④	⑥	⑤	⑥	⑤	⑦	⑦
		7	①	①	②	②	②	④	④	⑤	④	⑥	⑤	⑦	⑥	⑧	⑧
		7.5	①	①	②	②	②	④	④	⑤	⑤	⑥	⑤	⑦	⑥	⑧	⑧
		8	①	②	②	④	④	⑤	④	⑥	⑤	⑦	⑥	⑧	⑥		
		8.5	①	②	②	④	④	⑤	④	⑥	⑤	⑦	⑥	⑧	⑥		
		9	①	②	②	④	④	⑤	⑤	⑥	⑤	⑦	⑥	⑧	⑦		
		9.5	①	②	②	④	④	⑤	⑤	⑥	⑤	⑦	⑥		⑦		
		10	①	②	②	④	④	⑤	⑤	⑦	⑥	⑧	⑦		⑦		
		11	④	④	④	④	④	⑥	⑤	⑦	⑥	⑧	⑦		⑧		
	12	④	④	④	⑤	⑤	⑥	⑥	⑧	⑦		⑧					
	13	④	④	④	⑤	⑤	⑥	⑥	⑧	⑦		⑧					
	14	⑤	⑤	⑤	⑤	⑤	⑦	⑥		⑦							
	15	⑤	⑤	⑤	⑤	⑤	⑦	⑦		⑧							
	16	⑥	⑥	⑥	⑥	⑥	⑧	⑦		⑧							
	17	⑥	⑥	⑥	⑥	⑥	⑧	⑦									
	18	⑦	⑦	⑦	⑦	⑦	⑧	⑧									
	19	⑦	⑦	⑦	⑦	⑦		⑧									
	20	⑧	⑧	⑧	⑧	⑧		⑧									
	22																
	24																
	26																
	28																
	30																
	35																
2階建て	1	①	①	①	①	①	①	①	①	①	①	①	②	①	②		
	1.5	①	①	①	①	①	①	①	②	①	②	②	②	②	②		
	2	①	①	①	①	①	②	①	②	②	②	②	④	②	④		
	2.5	①	①	①	①	①	②	②	②	②	④	②	④	②	④		
	3	①	①	①	②	②	②	②	④	②	④	④	⑤	④	⑤		
	3.5	①	①	①	②	②	②	②	④	②	④	④	⑤	④	⑥		
	4	①	①	①	②	②	④	②	④	④	⑤	④	⑥	⑤	⑥		
	4.5	①	①	②	②	②	④	④	⑤	④	⑤	⑤	⑥	⑤	⑦		
	5	①	①	②	②	②	④	④	⑤	④	⑥	⑤	⑦	⑤	⑦		
	5.5	①	①	②	②	②	④	④	⑤	⑤	⑥	⑤	⑦	⑥	⑧		
	6	①	②	②	④	④	⑤	④	⑥	⑤	⑦	⑥	⑧	⑥			
	6.5	①	②	②	④	④	⑤	④	⑥	⑤	⑦	⑥	⑧	⑦			
	7	①	②	②	④	④	⑤	⑤	⑥	⑤	⑦	⑥		⑦			
	7.5	①	②	②	④	④	⑤	⑤	⑦	⑥	⑧	⑦		⑦			
	8	①	②	②	④	④	⑥	⑤	⑦	⑥	⑧	⑦		⑧			
	8.5	④	④	④	④	④	⑥	⑤	⑦	⑥		⑦		⑧			
	9	④	④	④	⑤	⑤	⑥	⑥	⑧	⑦		⑧					
	9.5	④	④	④	⑤	⑤	⑥	⑥	⑧	⑦		⑧					
	10	⑤	⑤	⑤	⑤	⑤	⑦	⑥	⑧	⑦		⑧					
	11	⑤	⑤	⑤	⑤	⑤	⑦	⑥		⑧							
12	⑥	⑥	⑥	⑥	⑥	⑧	⑦		⑧								
13	⑥	⑥	⑥	⑥	⑥	⑧	⑦										
14	⑦	⑦	⑦	⑦	⑦		⑧										
15	⑧	⑧	⑧	⑧	⑧		⑧										
16	⑧	⑧	⑧	⑧	⑧												
17																	
18																	
19																	
20																	
22																	
24																	
26																	
28																	
30																	
35																	

配筋表：基礎梁の開口部（柱間隔）直下の補強筋《 地中梁 》

【 多雪区域（1.5m以下） 重い屋根 】

《 補強筋凡例 》 ①：1-D13(15) ②：2-D13(縦)(15) ③：2-D13(横)(25) ④：3-D13(30)
 ⑤：4-D13(35) ⑥：5-D13(40) ⑦：6-D13(45) ⑧：7-D13(50)

※標準主筋をD13とする場合は下記スパン表内の②：2-D13（縦）（15）は③：2-D13（横）（25）に置き換える ※黒塗りつぶし箇所は配筋の適用範囲外です。

基礎梁成 (mm)	階数	負担面積 (㎡)	柱間隔 (m) と開口部位置													
			0 < 柱間隔 ≤ 0.91		0.91 < 柱間隔 ≤ 1.82		1.82 < 柱間隔 ≤ 2.73		2.73 < 柱間隔 ≤ 3.64		3.64 < 柱間隔 ≤ 4.55		4.55 < 柱間隔 ≤ 5.46		5.46 < 柱間隔 ≤ 6.37	
			中央寄り	片側寄り	中央寄り	片側寄り	中央寄り	片側寄り	中央寄り	片側寄り	中央寄り	片側寄り	中央寄り	片側寄り	中央寄り	片側寄り
500以上	平屋建て	1	①	①	①	①	①	①	①	①	①	①	①	①	①	①
		1.5	①	①	①	①	①	①	①	①	①	①	①	①	①	②
		2	①	①	①	①	①	①	①	①	①	②	②	①	②	②
		2.5	①	①	①	①	①	①	①	②	①	②	②	②	②	②
		3	①	①	①	①	①	①	①	②	②	②	②	②	②	④
		3.5	①	①	①	①	①	②	②	②	②	②	②	④	②	④
		4	①	①	①	①	①	②	②	②	②	④	②	④	④	⑤
		4.5	①	①	①	①	①	②	②	②	②	④	②	④	④	⑤
		5	①	①	①	②	②	②	②	④	②	④	④	⑤	④	⑤
		5.5	①	①	①	②	②	②	②	④	④	⑤	④	⑤	④	⑥
		6	①	①	①	②	②	②	②	④	④	⑤	④	⑤	⑤	⑥
		6.5	①	①	①	②	②	④	②	④	④	⑤	④	⑥	⑤	⑥
		7	①	①	②	②	②	④	④	⑤	④	⑤	⑤	⑥	⑤	⑦
		7.5	①	①	②	②	②	④	④	⑤	④	⑥	⑤	⑥	⑤	⑦
		8	①	①	②	②	②	④	④	⑤	④	⑥	⑤	⑦	⑥	⑧
		8.5	①	①	②	②	②	④	④	⑤	⑤	⑥	⑤	⑦	⑥	⑧
		9	①	①	②	②	②	④	④	⑤	⑤	⑥	⑤	⑦	⑥	⑧
		9.5	①	②	②	④	④	⑤	④	⑥	⑤	⑦	⑥	⑧	⑥	
		10	①	②	②	④	④	⑤	④	⑥	⑤	⑦	⑥	⑧	⑦	
		11	①	②	②	④	④	⑤	⑤	⑥	⑥	⑧	⑥		⑦	
		12	①	②	②	④	④	⑤	⑤	⑦	⑥	⑧	⑦		⑧	
		13	④	④	④	④	④	⑥	⑤	⑦	⑥		⑦		⑧	
		14	④	④	④	⑤	⑤	⑥	⑥	⑧	⑦		⑧			
		15	④	④	④	⑤	⑤	⑥	⑥	⑧	⑦		⑧			
		16	⑤	⑤	⑤	⑤	⑤	⑦	⑥		⑦					
		17	⑤	⑤	⑤	⑤	⑤	⑦	⑥		⑧					
		18	⑥	⑥	⑥	⑥	⑥	⑦	⑦		⑧					
		19	⑥	⑥	⑥	⑥	⑥	⑧	⑦		⑧					
		20	⑥	⑥	⑥	⑥	⑥	⑧	⑦							
		22	⑦	⑦	⑦	⑦	⑦		⑧							
	24	⑧	⑧	⑧	⑧	⑧										
	26															
	28															
	30															
	35															
500以上	2階建て	1	①	①	①	①	①	①	①	①	①	①	①	①	②	
		1.5	①	①	①	①	①	①	①	①	②	②	①	②	②	
		2	①	①	①	①	①	①	①	②	①	②	②	②	②	④
		2.5	①	①	①	①	①	②	①	②	②	②	②	④	②	④
		3	①	①	①	①	①	②	②	②	②	④	②	④	④	⑤
		3.5	①	①	①	②	②	②	②	④	②	④	④	⑤	④	⑤
		4	①	①	①	②	②	②	②	④	②	④	④	⑤	④	⑥
		4.5	①	①	①	②	②	②	②	④	④	⑤	④	⑤	⑤	⑥
		5	①	①	①	②	②	④	②	④	④	⑤	④	⑥	⑤	⑦
		5.5	①	①	②	②	②	④	④	⑤	④	⑥	⑤	⑥	⑤	⑦
		6	①	①	②	②	②	④	④	⑤	④	⑥	⑤	⑦	⑥	⑧
		6.5	①	①	②	②	②	④	④	⑤	⑤	⑥	⑤	⑦	⑥	⑧
		7	①	②	②	④	④	⑤	④	⑥	⑤	⑦	⑥	⑧	⑥	
		7.5	①	②	②	④	④	⑤	④	⑥	⑤	⑦	⑥	⑧	⑦	
		8	①	②	②	④	④	⑤	⑤	⑥	⑤	⑦	⑥		⑦	
		8.5	①	②	②	④	④	⑤	⑤	⑥	⑥	⑧	⑥		⑦	
		9	①	②	②	④	④	⑤	⑤	⑦	⑥	⑧	⑦		⑧	
		9.5	④	④	④	④	④	⑥	⑤	⑦	⑥	⑧	⑦		⑧	
		10	④	④	④	④	④	⑥	⑤	⑦	⑥		⑦		⑧	
		11	④	④	④	⑤	⑤	⑥	⑥	⑧	⑦		⑧			
		12	⑤	⑤	⑤	⑤	⑤	⑦	⑥		⑦					
		13	⑤	⑤	⑤	⑤	⑤	⑦	⑦		⑧					
		14	⑥	⑥	⑥	⑥	⑥	⑧	⑦		⑧					
		15	⑦	⑦	⑦	⑦	⑦	⑧	⑦							
		16	⑦	⑦	⑦	⑦	⑦		⑧							
		17	⑧	⑧	⑧	⑧	⑧		⑧							
		18	⑧	⑧	⑧	⑧	⑧									
		19														
		20														
		22														
	24															
	26															
	28															
	30															
	35															

配筋表：基礎梁の開口部（柱間隔）直下の補強筋《人通口》

【多雪区域（1.5m以下） 重い屋根 スラブ厚150mm】

《補強筋凡例》

①：D13

②：2-D13

③：5-D13

④：7-D13

⑤：9-D13

⑥：D13+7-D16

地⑦：地3-D16

地⑧：地5-D16

地⑨：地（50）5-D16

※黒塗りつぶし箇所は配筋の適用範囲外です。

尺モジュール

階数	負担面積 (m ²)	柱間隔 (m) と開口部位置													
		0 < 柱間隔 ≤ 0.91		0.91 < 柱間隔 ≤ 1.82		1.82 < 柱間隔 ≤ 2.73		2.73 < 柱間隔 ≤ 3.64		3.64 < 柱間隔 ≤ 4.55		4.55 < 柱間隔 ≤ 5.46		5.46 < 柱間隔 ≤ 6.37	
		中央寄り	片側寄り	中央寄り	片側寄り	中央寄り	片側寄り	中央寄り	片側寄り	中央寄り	片側寄り	中央寄り	片側寄り	中央寄り	片側寄り
平屋建て	1	①	①	①	①	①	①	①	②	①	②	②	②	②	②
	1.5	①	①	①	①	①	②	②	②	②	②	②	③	②	③
	2	①	①	①	②	②	②	②	②	③	③	④	③	④	④
	2.5	①	①	①	②	②	②	②	③	②	④	③	⑤	④	⑤
	3	①	①	②	②	②	③	②	④	③	⑤	④	⑤	④	⑥
	3.5	①	①	②	②	②	③	③	④	④	⑤	④	⑥	⑤	地⑦
	4	①	②	②	②	②	④	③	⑤	④	⑥	⑤	地⑦	⑥	地⑦
	4.5	①	②	②	③	③	④	④	⑤	⑤	⑥	⑤	地⑦	⑥	地⑦
	5	①	②	②	③	③	⑤	④	⑥	⑤	地⑦	⑥	地⑦	⑥	地⑦
	5.5	①	②	②	③	③	⑤	④	⑥	⑤	地⑦	⑥	地⑦	地⑦	地⑧
	6	②	②	②	④	④	⑤	⑤	地⑦	⑥	地⑦	地⑦	地⑧	地⑦	地⑧
	6.5	②	②	③	④	④	⑥	⑤	地⑦	⑥	地⑦	地⑦	地⑧	地⑦	地⑧
	7	②	②	③	④	④	⑥	⑥	地⑦	⑥	地⑧	地⑦	地⑧	地⑦	地⑨
	7.5	②	②	③	⑤	⑤	⑥	⑥	地⑦	地⑦	地⑧	地⑦	地⑧	地⑧	地⑨
	8	②	②	③	⑤	⑤	地⑦	⑥	地⑦	地⑦	地⑧	地⑦	地⑨	地⑧	地⑨
	8.5	②	②	④	⑤	⑤	地⑦	⑥	地⑦	地⑦	地⑧	地⑦	地⑨	地⑧	地⑨
	9	②	③	④	⑤	⑤	地⑦	地⑦	地⑧	地⑦	地⑧	地⑧	地⑨	地⑧	地⑨
	9.5	②	③	④	⑥	⑥	地⑦	地⑦	地⑧	地⑦	地⑨	地⑧	地⑨	地⑧	地⑨
	10	②	③	④	⑥	⑥	地⑦	地⑦	地⑧	地⑦	地⑨	地⑧	地⑨	地⑧	地⑨
	11	②	③	④	⑥	⑥	地⑦	地⑦	地⑧	地⑧	地⑨	地⑧	地⑨	地⑧	地⑨
	12	②	④	⑤	地⑦	地⑦	地⑧	地⑦	地⑨	地⑧	地⑨	地⑨	地⑨	地⑧	地⑨
	13	③	④	⑤	地⑦	地⑦	地⑧	地⑦	地⑨	地⑧	地⑨	地⑨		地⑨	
	14	③	④	⑥	地⑦	地⑦	地⑧	地⑧	地⑨	地⑧	地⑨	地⑨		地⑨	
	15	③	⑤	⑥	地⑦	地⑦	地⑧	地⑧	地⑨	地⑨	地⑨	地⑨		地⑨	
	16	③	⑤	⑥	地⑦	地⑦	地⑨	地⑧	地⑨	地⑨		地⑨		地⑨	
	17	④	⑤	⑥											
	18	④	⑤												
	19	④	⑥												
	20	④	⑥												
	22	④	⑥												
	24	⑤													
	26	⑤													
	28	⑥													
	30	⑥													
	35	⑥													
2階建て	1	①	①	①	①	①	②	①	②	②	②	②	②	②	③
	1.5	①	①	①	②	②	②	②	②	③	③	④	③	④	④
	2	①	①	①	②	②	②	②	③	③	④	③	⑤	④	⑥
	2.5	①	①	②	②	②	③	③	④	④	⑤	④	⑥	⑤	⑥
	3	①	②	②	②	②	④	③	⑤	④	⑥	⑤	地⑦	⑥	地⑦
	3.5	①	②	②	③	③	④	④	⑥	⑤	⑥	⑥	地⑦	⑥	地⑦
	4	①	②	②	③	③	⑤	④	⑥	⑤	地⑦	⑥	地⑦	地⑦	地⑧
	4.5	②	②	②	④	④	⑤	⑤	地⑦	⑥	地⑦	地⑦	地⑧	地⑦	地⑧
	5	②	②	③	④	④	⑥	⑤	地⑦	⑥	地⑦	地⑦	地⑧	地⑦	地⑧
	5.5	②	②	③	④	④	⑥	⑥	地⑦	地⑦	地⑧	地⑦	地⑧	地⑦	地⑨
	6	②	②	③	⑤	⑤	地⑦	⑥	地⑦	地⑦	地⑧	地⑦	地⑨	地⑧	地⑨
	6.5	②	③	④	⑤	⑤	地⑦	⑥	地⑦	地⑦	地⑧	地⑧	地⑨	地⑧	地⑨
	7	②	③	④	⑥	⑥	地⑦	地⑦	地⑧	地⑦	地⑧	地⑧	地⑨	地⑧	地⑨
	7.5	②	③	④	⑥	⑥	地⑦	地⑦	地⑧	地⑦	地⑨	地⑧	地⑨	地⑧	地⑨
	8	②	③	④	⑥	⑥	地⑦	地⑦	地⑧	地⑧	地⑨	地⑧	地⑨	地⑧	地⑨
	8.5	②	④	⑤	⑥	⑥	地⑦	地⑦	地⑧	地⑧	地⑨	地⑧	地⑨	地⑧	地⑨
	9	②	④	⑤	地⑦	地⑦	地⑧	地⑦	地⑨	地⑧	地⑨	地⑨	地⑨	地⑧	地⑨
	9.5	②	④	⑤	地⑦	地⑦	地⑧	地⑦	地⑨	地⑧	地⑨	地⑨		地⑨	
	10	③	④	⑤	地⑦	地⑦	地⑧	地⑧	地⑨	地⑧	地⑨	地⑨		地⑨	
	11	③	④	⑥	地⑦	地⑦	地⑧	地⑧	地⑨	地⑧	地⑨	地⑨		地⑨	
	12	③	⑤	⑥	地⑦	地⑦	地⑨	地⑧	地⑨	地⑧	地⑨			地⑨	
	13	④	⑤	⑥											
	14	④	⑥												
	15	④	⑥												
	16	④	⑥												
	17	⑤	⑥												
	18	⑤													
	19	⑤													
	20	⑤													
	22	⑥													
	24	⑥													
	26	⑥													
	28														
	30														
	35														

配筋表：基礎梁の隅角部の主筋補強

【基礎幅150mm】

尺モジュール

《補強筋凡例》 ①：D13 ②：D13+D10 ③：2-D13 ④：D13+D16 ⑤：2-D16

※標準主筋が2-D13の場合、配筋表のD13、D13+D10は2-D13で置き換えてください。 ※黒塗りつぶし箇所は配筋の適用範囲外です。

基礎梁成 (mm)	告示表三	Nの値	引抜き (kN)	耐力壁長さ(柱間)		
				0.91 (m) 以下	1.365 (m) 以下	1.82 (m) 以下
400 以上	(は) 以下	1以下	5.1	①	①	①
	(に)	1.4以下	7.5	①	②	②
	(ほ)	1.6以下	8.5	①	②	③
	(へ)	1.8以下	10	①	②	③
	(と)	2.8以下	15	②	④	⑤
	(ち)	3.7以下	20	③	⑤	
	(り)	4.7以下	25	④		
	(ぬ)	5.6以下	30	⑤		
450 以上	(は) 以下	1以下	5.1	①	①	①
	(に)	1.4以下	7.5	①	①	②
	(ほ)	1.6以下	8.5	①	②	②
	(へ)	1.8以下	10	①	②	③
	(と)	2.8以下	15	②	③	④
	(ち)	3.7以下	20	③	④	
	(り)	4.7以下	25	③	⑤	
	(ぬ)	5.6以下	30	④		
500 以上	(は) 以下	1以下	5.1	①	①	①
	(に)	1.4以下	7.5	①	①	②
	(ほ)	1.6以下	8.5	①	①	②
	(へ)	1.8以下	10	①	②	②
	(と)	2.8以下	15	②	③	④
	(ち)	3.7以下	20	②	④	⑤
	(り)	4.7以下	25	③	⑤	
	(ぬ)	5.6以下	30	④		
520 以上	(は) 以下	1以下	5.1	①	①	①
	(に)	1.4以下	7.5	①	①	①
	(ほ)	1.6以下	8.5	①	①	②
	(へ)	1.8以下	10	①	①	②
	(と)	2.8以下	15	①	②	③
	(ち)	3.7以下	20	②	③	⑤
	(り)	4.7以下	25	③	④	
	(ぬ)	5.6以下	30	③	⑤	
670 以上	(は) 以下	1以下	5.1	①	①	①
	(に)	1.4以下	7.5	①	①	①
	(ほ)	1.6以下	8.5	①	①	①
	(へ)	1.8以下	10	①	①	①
	(と)	2.8以下	15	①	②	②
	(ち)	3.7以下	20	①	②	③
	(り)	4.7以下	25	②	③	④
	(ぬ)	5.6以下	30	②	④	⑤
850 以上	(は) 以下	1以下	5.1	①	①	①
	(に)	1.4以下	7.5	①	①	①
	(ほ)	1.6以下	8.5	①	①	①
	(へ)	1.8以下	10	①	①	①
	(と)	2.8以下	15	①	①	②
	(ち)	3.7以下	20	①	②	②
	(り)	4.7以下	25	①	②	③
	(ぬ)	5.6以下	30	②	③	④
(35)	6.6以下	35	②	③	⑤	